



DATASHEET

SCREWDRIVER

v1.4

1. Datasheet

1.1. Screwdriver

General Properties		Minimum	Typical	Maximum	Unit
Tightening torque range		0.15	-	5	[Nm]
		0.11	-	3.68	[lbft]
Tightening torque accuracy*	If torque < 1.33 Nm/ 0.98 lbft	-	0.04 0.03	-	[Nm] [lbft]
	If torque > 1.33 Nm/ 0.98 lbft	-	3	-	[%]
Self-tapping torque		-	85% of the tightening torque	3	[Nm]
Pre-mount accuracy error**		-	-	0.5	[mm]
Output speed		-	-	340	[RPM]
Screw length within full safety		-	-	35	[mm]
		-	-	1.37	[inch]
Shank stroke (screw axis)		-	-	55	[mm]
		-	-	2.16	[inch]
Shank preload (adjustable)		0	10	25	[N]
Protective feature force		35	40	45	[N]
Storage temperature		0	-	60	[°C]
		32	-	140	[°F]
Motor (x2)		Integrated, electric BLDC			
IP Classification		IP54			
ESD Safe		Yes			
Dimensions		308 x 86 x 114			[mm]
		12.1 x 3.4 x 4.5			[inch]
Weight		2.5			[kg]
		5.51			[lb]









* See [Torque Accuracy Graph](#) for further information.

** The pitch of the screw might contribute to the total pre-mount accuracy error.

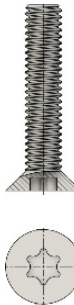
Operating Conditions	Minimum	Typical	Maximum	Unit
Power supply	20	24	25	[V]
Current consumption	75	-	4500	[mA]

Operating Conditions	Minimum	Typical	Maximum	Unit
Operating temperature	5	-	50	[°C]
	41	-	122	[°F]
Relative humidity (non-condensing)	0	-	95	[%]
Calculated operation life	30 000	-	-	[Hours]

Supported Screws

Supported Screws Metric						
Material type	Magnetic					
Screw length	Up to 50 mm (35 mm thread length)					
Head type	Cylinder			Counter sunk	Button head	
Appearance						
Standard	Din 912 / ISO 4762 	ISO 14579 	ISO 14580 	ISO 14581 	DIN 7985A 	
Supported Thread Size	M1.6	✓	N/A	N/A	N/A	N/A
	M2	✓	✓	N/A	✓	✓
	M2.5	✓	✓	N/A	✓	✓
	M3	✓	✓	✓	✓	✓
	M4	✓	✓	✓	✓	✓
	M5	✓	✓	✓	✓	✓
	M6	✓	✓	✓	✓	✓

Supported Screws US Standard	
Material type	Magnetic



Supported Screws US Standard						
Screw length		Up to 1.96 inches (1.37 inches thread length)				
Head type		Cylinder	Button head		Counter sunk	
Appearance						
Standard		ASME B18.3	ASME B18.6.3	ASME B18.6.3	ASME B18.3	ASME B18.6.3
Supported Thread Size	1#	✓	N/A	N/A	N/A	N/A
	2#	✓	✓	✓	N/A	✓
	4#	✓	✓	✓	✓	✓
	6#	✓	✓	✓	✓	✓
	8#	✓	✓	✓	✓	✓
	10#	✓	✓	✓	✓	✓
	12#	N/A	✓	✓	N/A	N/A
	1/4"	✓	N/A	N/A	✓	N/A

Supported Self-tapping Screws for Aluminium 1/2					
Material type		Magnetic			
Screw length		Up to 50 mm (35 mm thread length)			
Head type		Pan head		Flat round with flange	Lens head
Appearance					

Supported Self-tapping Screws for Aluminium 1/2				
Standard	DIN 7981 C/ ISO 7049	DIN 7981 F/ ISO 7049	WN 5251	DIN 7983 C
Thread size and Bit holder/ Bit extender	Bit, screw carrier and screw fix needed			
ST2.2 / 2.2 / KB22 / K22	✓	✓	N/A	✓
ST 2.9	✓	✓	N/A	✓
3 / M3 / KB30 / K30	N/A	N/A	✓	N/A
ST3.5.3 / 3.5 / KB35 / K35	✓	✓	✓	✓
ST 3.9	N/A	✓	N/A	N/A
4 / M4 / KB40 / K40	N/A	N/A	✓	N/A
ST 4.2	✓	✓	N/A	✓
ST 4.8	✓	N/A	N/A	✓
50 / M5 / KB50 / K50	N/A	N/A	✓	N/A
ST 5.5	✓	N/A	N/A	N/A
ST 6.3	✓	N/A	N/A	N/A

Supported Self-tapping Screws for Aluminium 2/2			
Material type	Magnetic		
Screw length	Up to 50 mm (35 mm thread length)		
Head type	Counter sunk		
Appearance			
Standard	DIN 7500 M	DIN 14586 C	DIN 7982 C
Thread size and Bit holder/ Bit extender	Bit, screw carrier and screw fix needed		
20 / M2 / K20	✓	N/A	N/A
ST2.2 / 2.2 / KB22 / K22	N/A	✓	✓

Supported Self-tapping Screws for Aluminium 2/2			
2.5 / M2.5 / KB25 / K25	✓	N/A	N/A
ST 2.9	N/A	✓	✓
3 / M3 / KB30 / K30	✓	N/A	N/A
ST3.5.3 / 3.5 / KB35 / K35	N/A	✓	✓
ST 3.9	N/A	✓	✓
4 / M4 / KB40 / K40	✓	N/A	N/A
ST 4.2	N/A	✓	✓
ST 4.8	N/A	✓	✓
50 / M5 / KB50 / K50	✓	N/A	N/A
ST 5.5	N/A	✓	✓
60 / M6	✓	N/A	N/A
ST 6.3	N/A	✓	✓

Supported Self-tapping Screws for Plastic			
Material type	Magnetic		
Screw length	Up to 50 mm (35 mm thread length)		
Head type	Counter sunk	Flat round with flange	
Appearance			
Standard	ISO 4042	WN 1411	WN 5451
Thread size and Bit holder/ Bit extender	Bit, screw carrier and screw fix needed		
20 / M2 / K20	N/A	N/A	✓
ST2.2 / 2.2 / KB22 / K22	✓	N/A	✓
2.5 / M2.5 / KB25 / K25	✓	✓	✓
3 / M3 / KB30 / K30	✓	✓	✓

Supported Self-tapping Screws for Plastic			
ST3.5.3 / 3.5 / KB35 / K35	✓	✓	N/A
4 / M4 / KB40 / K40	✓	✓	✓
50 / M5 / KB50 / K50	N/A	✓	✓
60 / M6	N/A	N/A	✓

Guidance on Achievable Depth for Self-tapping Screws

How deep a screw can be self-tapped highly depends on the screw material and the workpiece material. There are three examples below of what the maximum depth is for a specific screw to go into a specific material.

Example of WN 1411 in POM

Screw Size	Depth
K18x10	10
K20x10	10
K22x16	16
K25x16	16
K30x20	20
K35x30	30
K40x30	30
K50x30	30

Example of WN 1411 in NYLON PA Type 6

Screw Size	Depth
K18x10	10
K20x10	10
K22x16	16
K25x16	16
K30x20	20

Screw Size	Depth
K35x30	30
K40x30	30
K50x30	30

Example of DIN 7500 M in Aluminium EN AW-5754

Screw Size	Depth
M2x12	12
M2.5x20	20
M3x30	25
M4x30	30
M5x30	30
M6x30	11

There are three potential outcomes when testing a self-tapping screw:

1. The screw goes all the way in and is tightened with the set target torque. This is successful operation.
2. The screw breaks while screwing in and the Screwdriver returns a result code / runtime error: 10 - "Torque dropped unexpectedly". This means that the screw cannot handle such high torque on a material that hard.
3. The Screwdriver stops halfway through and returns a result code / runtime error: 4 - "Torque exceeded prematurely". This means that a higher torque is needed to go through that material with that screw. A solution could be to set a higher tightening torque.

For a successful tapping, ensure that the hole is made according to the screw manufacturer specifications.

Torque accuracy Metric

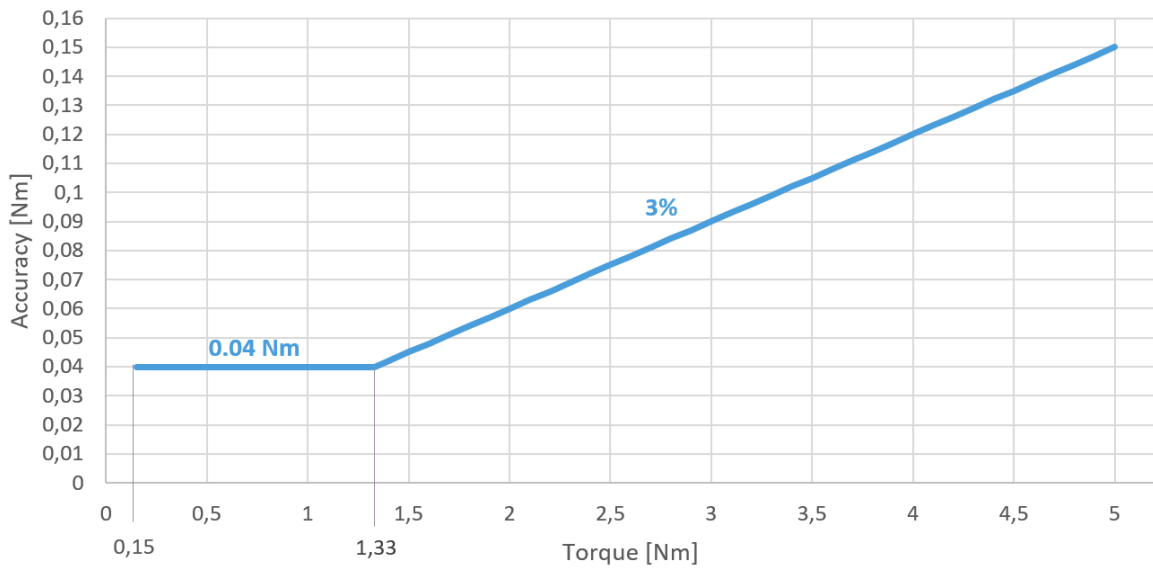

Torque accuracy US Standard

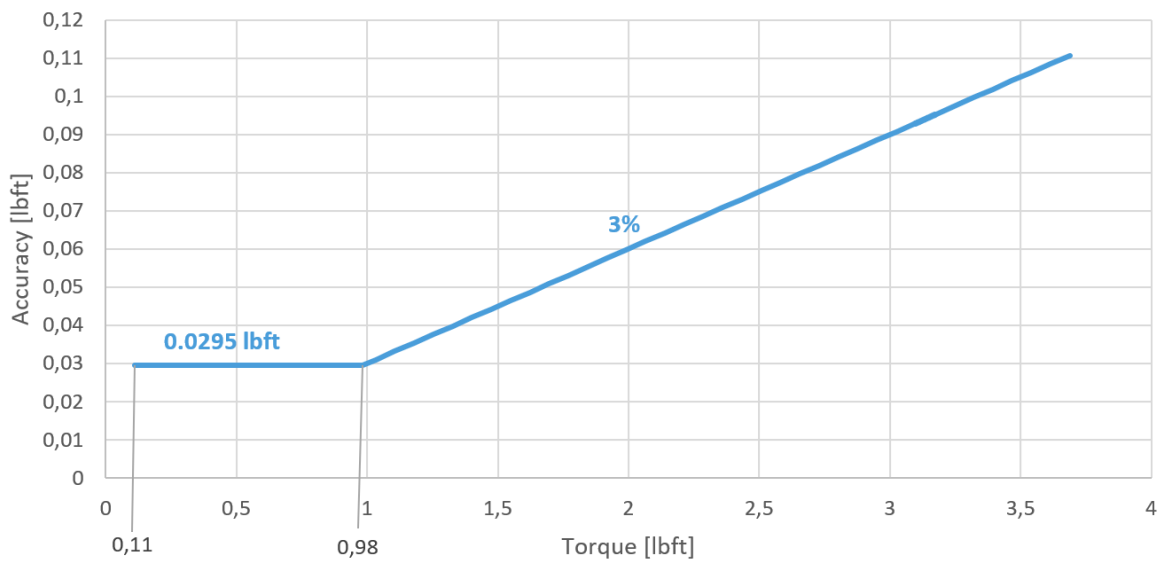

Screw-bit System

This system will highly increase the efficacy of the screws to be picked up, aligned with the bit, moved around with the Screwdriver and screwed in/out. Therefore, it is highly recommended to set up the Screw-bit System correctly to keep a high success rate.

Example of the Screw-bit System for an ISO 14579, M2 screw.

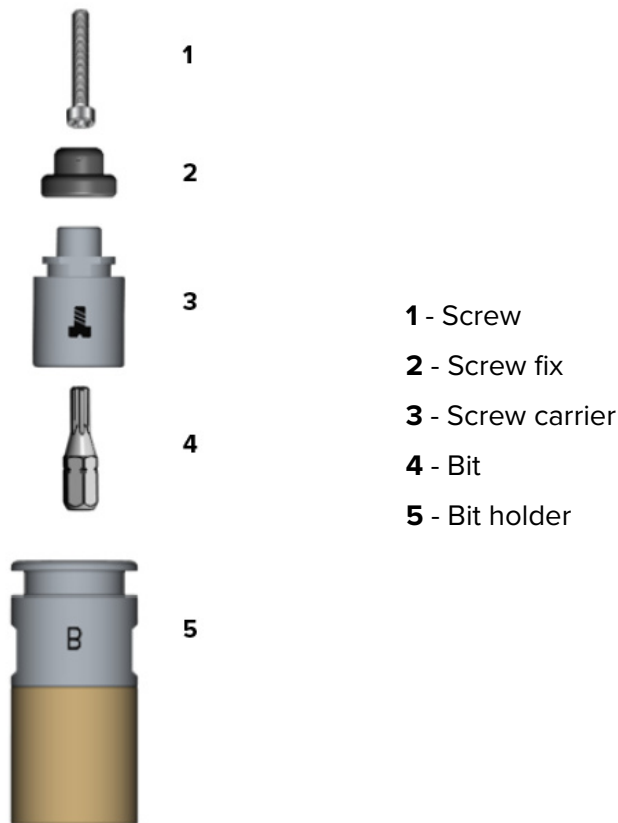

The following sections explain the different components of the Screw-bit System and how to set it up correctly.

Screws

The first step is to know what type of screw is going to be used. The screw type will define what type of screw fix (in any), screw carrier, bit, and bit holder shall be used.



NOTE:

Use a chamfer for better reliability when making the screw hole.

The recommended screw types for the Screwdriver are the ones that have the properties mentioned previously in the **Supported Screws** tables.

Screw Fix and Screw Carrier

Select the right screw fix and screw carrier depending on the screw type and the size to maximize the efficacy of the Screw-bit System based on the table in section:

- **Metric Screws**
- **US Standard Screws**
- **Self-tapping Screws for Aluminium**
- **Self-tapping Screws for Plastic**

The screw fixes are needed for the DIN 912, ISO 4762, ISO 14579, ISO 14580, DIN 7981C / ISO 7049, DIN 7981F / ISO 7049, WN 5251, WN 1411, WN 5451 and ASME B18.3 HEX Cylinder screw types. The screw fixes have signifiers to show what size of screw they support.

Screw fixes for Metric - DIN 912, ISO 4762, ISO 14579, ISO 14580, DIN 7981C / ISO 7049, DIN 7981F / ISO 7049, WN 5251, WN 1411, WN 5451						
M1.6	M2	M2.5	M3	M4	M5	M6

Screw fixes for US Standard - ASME B18.3 HEX Cylinder, DIN 7981C / ISO 7049, DIN 7981F / ISO 7049, WN 5251, WN 5451						
1#	2#	4#	6#	8#	10#	1/4"

The screw carriers also have signifiers to help identifying what screw type and size they can be used with.

Screw thread size	Screw type illustration

Bits

Select the right bit depending on the screw type and size to maximize the efficacy of the Screw-bit System based on the table in section:

- [Metric Screws](#)
- [US Standard Screws](#)
- [Self-tapping Screws for Aluminium](#)
- [Self-tapping Screws for Plastic](#)

The bits have signifiers to help identifying what bit type and size they are.

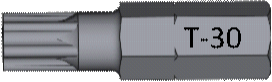
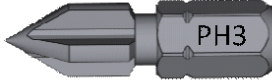
Screw type standard	Shows bit size and type
Din 912 / ISO 4762 ASME B18.3 HEX Cylinder	
ISO 14579 ISO 14580 ISO 14581 DIN 7500 M DIN 14586 C WN 5251 ISO 4042 WN 5451 ASME B18.6.3 Torx Button head ASME B18.6.3 Torx Counter sunk	
DIN 7985A DIN 7981C / ISO 7049 DIN 7981F / ISO 7049 DIN 7982 C DIN 7983 C WN 1411 ASME B18.6.3 Cross recessed Button head	

Supported bit shank properties:

- Type 1/4" HEX
- Length 25 mm



NOTE:

Bits longer than 25 mm could be used. However, the screw carrier and the screw fix might not hold the screw properly in place.

Bit Holder

Select the right bit holder depending on the screw type and size to maximize the efficacy of the Screw-bit System based on the table in section:

- [Metric Screws](#)
- [US Standard Screws](#)
- [Self-tapping Screws for Aluminium](#)
- [Self-tapping Screws for Plastic](#)

The bit holder generates a magnetic force that will keep the screw attached and aligned to the bit.

There are two types of bit holders:

- **Bit Holder A:** Generates a higher magnetic force. It is commonly used for the bigger and heavier screws.
- **Bit Holder B:** Generates a lower magnetic force. It is commonly used for the smaller and lighter screws.



WARNING:

If Bit Holder A is used for smaller and lighter screws instead of Bit Holder B, the screws can jump from the Screw Feeder to the Screwdriver because of the higher magnetic force.

Bit Extenders 50 and 100 mm

The bit extenders are a long version of the previously described bit holders. Bit extenders are useful to reach narrow spaces.

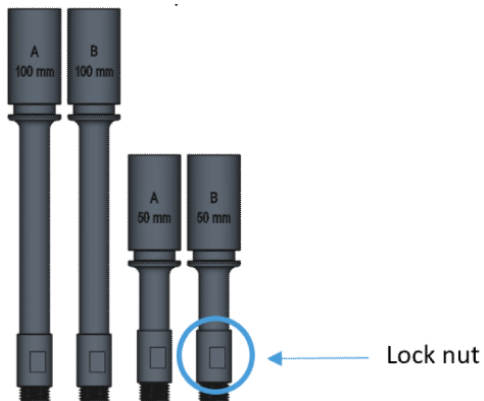

The bit extenders have a lock nut to tighten against the screw carrier to ensure that the screw carrier does not move out of position over time.

When the bit extenders are mounted on the Screwdriver, the maximum total radial runout can be up to 0.5 mm (measured below the thread as shown in the following picture).



The bit extenders need to be purchased separately by contacting your vendor where the Screwdriver was purchased.

- Bit extender type A 50 mm - PN 109301
- Bit extender type B 50 mm - PN 109289
- Bit extender type A 100 mm - PN 109290
- Bit extender type B 100 mm - PN 109298

For more information on the mechanical dimensions, go to the [Mechanical Drawings](#) section.

Set up the Screw-bit System

1. Place the bit into the bit holder.





2. Place the screw carrier on the bit holder.



3. All screw carriers must be adjusted so that the screw head sits stable on the screw carrier avoiding a gap in between. This needs to be done to ensure high performance of the Screw-bit System.
See the pictures below as reference.

Appearance	Adjustment method



Appearance	Adjustment method

Din 912 / ISO 4762 / ISO 14579 / ISO 14580 / ASME B18.3 Hex Cylinder		ISO 14581 / ASME B18.6 HEX Counter sunk / ASME B18.6.3 Torx Counter sunk		DIN 7985A / ASME B18.6.3 Cross recessed Button head / ASME B18.6.3 Torx Button head	

4. When this is achieved, remove the screw and push in the screw fix (only Din 912, ISO 4762, ISO 14579, ISO 14580 and ASME B18.3 HEX Cylinder screw types).

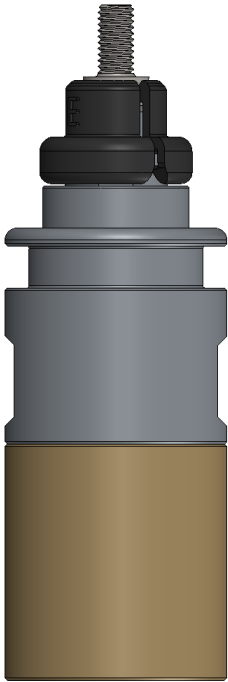
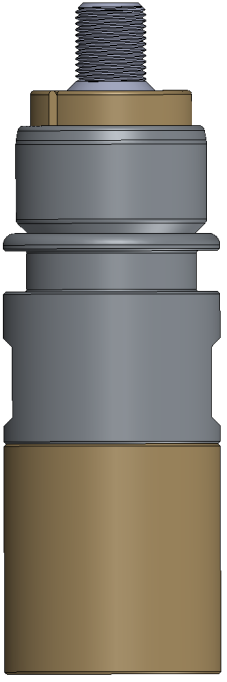
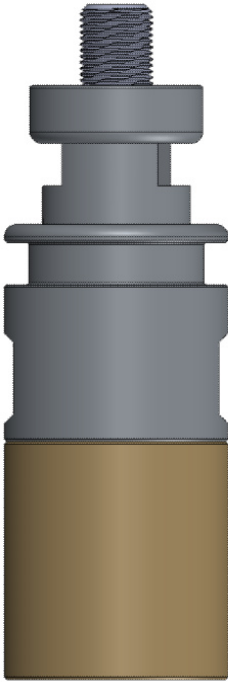

The final setup of the Screw-bit System with the screw in place should look like in the pictures below.

Screw standard	Din 912 / ISO 4762 / ISO 14579 / ISO 14580 / ASME B18.3 Hex Cylinder		ISO 14581 / ASME B18.6 HEX Counter sunk / ASME B18.6.3 Torx Counter sunk		DIN 7985A / ASME B18.6.3 Cross recessed Button head / ASME B18.6.3 Torx Button head	
Screw-bit System appearance						

Attaching the Screw-bit System to the Screwdriver

To attach the Screw-bit System to the Screwdriver, follow the instructions below.

1. Move the shank to the highest possible value by using the user interface in the robot or in the Web Client.
2. Detach the Screwdriver from the Quick Changer.

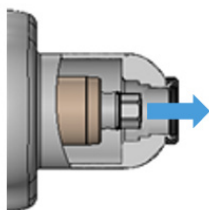

3. Remove the lid.

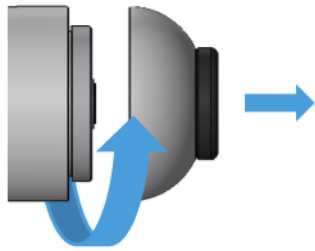

4. Place the hex shape of the bit holder inside of the end of the Screwdriver's shank. The system will be attached to the Screwdriver by a magnetic force.

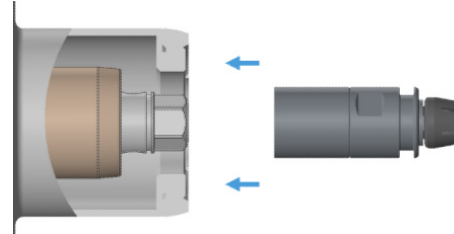

5. Ensure that the bit holder is perfectly attached by gently shaking it to make sure it is not loose.

Detaching the Screw-bit System from the Screwdriver

To remove the Screw-bit System from the Screwdriver's shank, follow the instructions below.

1. Move the shank all the way out to the highest possible value by operating the user interface in the robot or in the Web Client.
2. Use the provided key to grab the bit holder. While holding the key, move the shank inwards (to a lower value) by operating the user interface in the robot or in the Web Client.

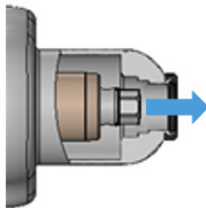

Overview of the Items Needed Depending on the Screw Type and Size

In the following tables, an overview is shown of the items needed depending on the screw type and size. Based on what screw type and size you have, search for the screw standard and the thread size and find what kind of bit, screw fix, screw carrier and bit holder you will need.

Items Needed Depending on Screw Type and Size for Metric Screws					
Head type	Cylinder			Counter sunk	Button head
Screw Standard	Din 912 / ISO 4762	ISO 14579	ISO 14580	ISO 14581	DIN 7985A
Thread Size	Bit holder, bit, screw carrier and screw fix needed				
M1.6		N/A	N/A	N/A	N/A
M2			N/A		
M2.5			N/A		
M3					
M4					
M5					
M6					

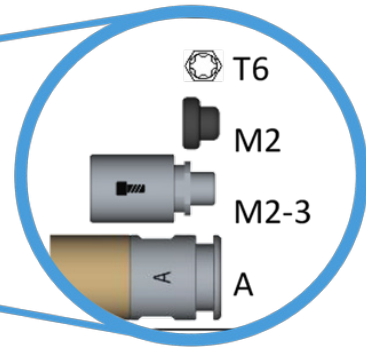

For more information, see the [example](#).













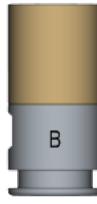







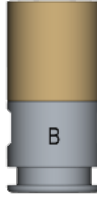





































Items Needed Depending on Screw Type and Size for Metric Screws



Items Needed Depending on Screw Type and Size for Metric Screws					
Head type	Cylinder			Counter sunk	Button head
Screw standard	Din 912 / ISO 4762	ISO 14579	ISO 14580	ISO 14581	DIN 7985A
Thread Size	Bit holder, bit, screw carrier and screw fix needed				
M1.6		N/A	N/A	N/A	N/A
M2			N/A		

Items Needed Depending on Screw Type and Size for Metric Screws					
M2.5	S2 M2.5 M2-3 A	T8 M2.5 M2-3 A	N/A	T8 M2.5 B	PH1 M2.5 B
M3	S2.5 M3 M2-3 A	T10 M3 M2-3 A	T10 M3 M2-3 A	T10 M3 A	PH1 M3 A
M4	S3 M4 M4-6 A	T20 M4 M4-6 A	T20 M4 M4-6 A	T20 M4 A	PH2 M4 A
M5	S4 M5 M4-6 A	T25 M5 M4-6 A	T25 M5 M4-6 A	T25 M5 A	PH2 M5 A
M6	S5 M6 M4-6 A	T30 M6 M4-6 A	T30 M6 M4-6 A	T30 M6 A	PH3 M6 A





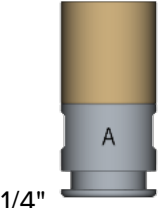

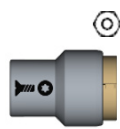

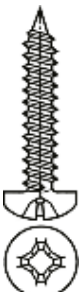
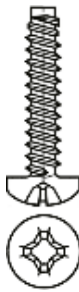

Items Needed Depending on Screw Type and Size for US Standard Screws

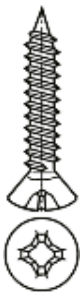
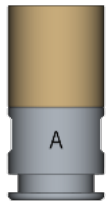



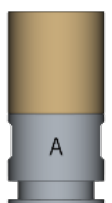



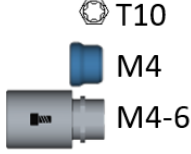

Items Needed Depending on Screw Type and Size for US Standard Screws						
Head type	Cylinder		Button head		Counter sunk	
Screw standard	ASME B18.3		ASME B18.6.3		ASME B18.3	
	HEX		Cross recessed	Torx	HEX	Torx
Thread Size	Bit holder, bit, screw carrier and screw fix needed					

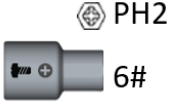
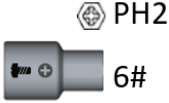
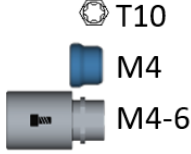
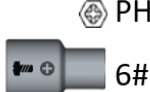

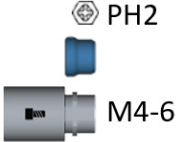

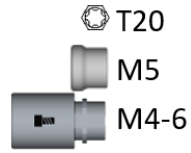

Items Needed Depending on Screw Type and Size for US Standard Screws					
1# 	 H1/16"  1#	N/A	N/A	N/A	N/A
2# 	 H5/64"  2#-6#	 PH1  2#	 T8  2#	N/A	 T6  2#
4# 	 H3/32"  2#-6#	 PH1  4#	 T10  4#	 H1/16"  4#	 T8  4#
6# 	 H7/64"  2#-6#	 PH1  6#	 T15  6#	 H5/64"  6#	 T10  6#
8# 	 H9/64"  8#-1/4"	 PH2  8#	 T20  8#	 H3/32"  8#	 T15  8#
10# 	 H5/32"  8#-1/4"	 PH2  10#	 T25  10#	 H1/8"  10#	 T20  10#
12# 	N/A	 PH3  12#	 T27  12#	N/A	N/A

Items Needed Depending on Screw Type and Size for US Standard Screws						
 1/4"	 H3/16"	 8#-1/4"	N/A	N/A	 T30 1/4"	N/A

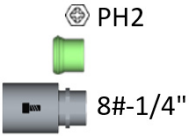

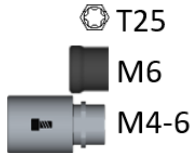





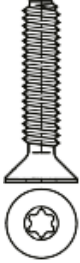
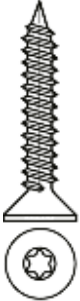
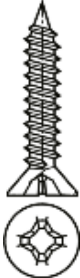

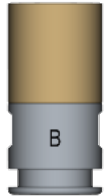
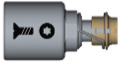

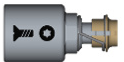
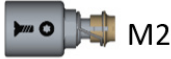
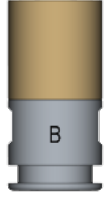
Items Needed Depending on Screw Type and Size for Self-tapping Screws for Aluminium



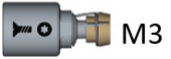

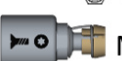





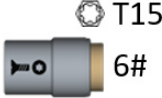



Items Needed Depending on Screw Type and Size for Self-tapping Screws for Aluminium 1/2				
Head type	Pan head		Flat round with flange	Lens head
Appearance				
Standard	DIN 7981 C / ISO 7049	DIN 7981 F / ISO 7049	WN 5251	DIN 7983 C
Thread Size	Bit, screw carrier and screw fix needed			
ST2.2 / 2.2 / KB22 / K22 	 PH1 M2	 PH1 M2	N/A	 PH1 M2
ST 2.9 	 PH1 4#	 PH1 4#	N/A	 PH1 4#





Items Needed Depending on Screw Type and Size for Self-tapping Screws for Aluminium 1/2				
3 / M3 / KB30 / K30 	N/A	N/A		N/A
ST3.5.3 / 3.5 / KB35 / K35 				
ST 3.9 	N/A		N/A	N/A
4 / M4 / KB40 / K40 	N/A	N/A		N/A
ST 4.2 			N/A	

Items Needed Depending on Screw Type and Size for Self-tapping Screws for Aluminium 1/2				
ST 4.8 	 PH2 8#-1/4"	N/A	N/A	 PH2 10#
50 / M5 / KB50 / K50 	N/A	N/A	 T25 M6 M4-6	N/A
ST 5.5 	 PH3 12#	N/A	N/A	N/A
ST 6.3 	 PH3 M6	N/A	N/A	N/A







Items Needed Depending on Screw Type and Size for Self-tapping Screws for Aluminium 2/2			
Head type	Counter sunk		
Appearance			
Standard	DIN 7500 M	DIN 14586 C	DIN 7982 C







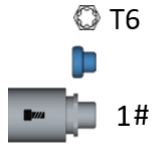

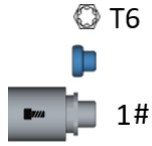

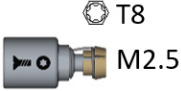



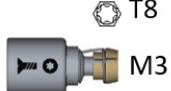



Items Needed Depending on Screw Type and Size for Self-tapping Screws for Aluminium 2/2			
Thread Size	Bit, screw carrier and screw fix needed		
20 / M2 / K20 	 T6 M2	N/A	N/A
ST2.2 / 2.2 / KB22 / K22 	N/A	 T6 M2	 PH1 M2
2.5 / M2.5 / KB25 / K25 	 T8 M2.5	N/A	N/A
ST 2.9 	N/A	 T8 M3	 PH1 M3
3 / M3 / KB30 / K30 	 T10 M3	N/A	N/A
ST3.5.3 / 3.5 / KB35 / K35 	N/A	 T15 6#	 PH2 6#

Items Needed Depending on Screw Type and Size for Self-tapping Screws for Aluminium 2/2			
ST 3.9 	N/A		
4 / M4 / KB40 / K40 		N/A	N/A
ST 4.2 	N/A		
ST 4.8 	N/A		
50 / M5 / KB50 / K50 		N/A	N/A
ST 5.5 	N/A		

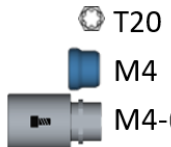
Items Needed Depending on Screw Type and Size for Self-tapping Screws for Aluminium 2/2			
60 / M6 		N/A	N/A
ST 6.3 	N/A		

Items Needed Depending on Screw Type and Size for Self-tapping Screws for Plastic

Items Needed Depending on Screw Type and Size for Self-tapping Screws for Plastic			
Head type	Counter sunk	Flat round with flange	
Appearance			
Standard	ISO 4042	WN 1411	WN 5451
Thread size and Bit holder/ Bit extender	Bit, screw carrier and screw fix needed		
20 / M2 / K20 	N/A	N/A	
ST2.2 / 2.2 / KB22 / K22 		N/A	

Items Needed Depending on Screw Type and Size for Self-tapping Screws for Plastic			
<p>2.5 / M2.5 / KB25 / K25</p> 	 <p>T8 M2.5</p>	 <p>PH1 M2</p>	 <p>T8 M2</p>
<p>3 / M3 / KB30 / K30</p> 	 <p>T8 M3</p>	 <p>PH1 M2.5</p>	 <p>T10 4#</p>
<p>ST3.5.3 / 3.5 / KB35 / K35</p> 	 <p>T15 M4</p>	 <p>PH2 M3</p>	N/A
<p>4 / M4 / KB40 / K40</p> 	 <p>T20 M4</p>	 <p>PH2 M3</p>	 <p>T20 M4 M4-6</p>
<p>50 / M5 / KB50 / K50</p> 	N/A	 <p>PH2 M4</p>	 <p>T25 8#-1/4"</p>
<p>60 / M6</p> 	N/A	N/A	 <p>T30 12#</p>

Screwdriver Position to Execute Commands

To successfully execute the Screwdriver commands, it is fundamental to position the Screwdriver correctly. This is achieved if the following two conditions are met:

1. The Screw-bit System must be perfectly aligned to the screw or thread.
2. The distance between the Screwdriver's bottom part and the surface where the action takes place must be within the range of 0-8 mm [0-0.31 inches].

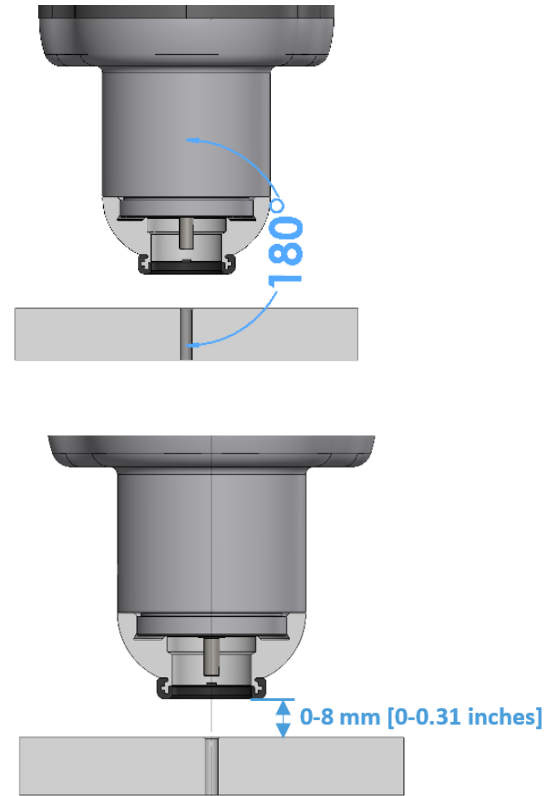

To successfully execute the Screwdriver commands, it is fundamental to operate the Screwdriver downwards or maximum sideways. The Screwdriver should not be operated upwards or with an angle higher than 90° orientate with respect to the ground, since this will trigger the protective feature.

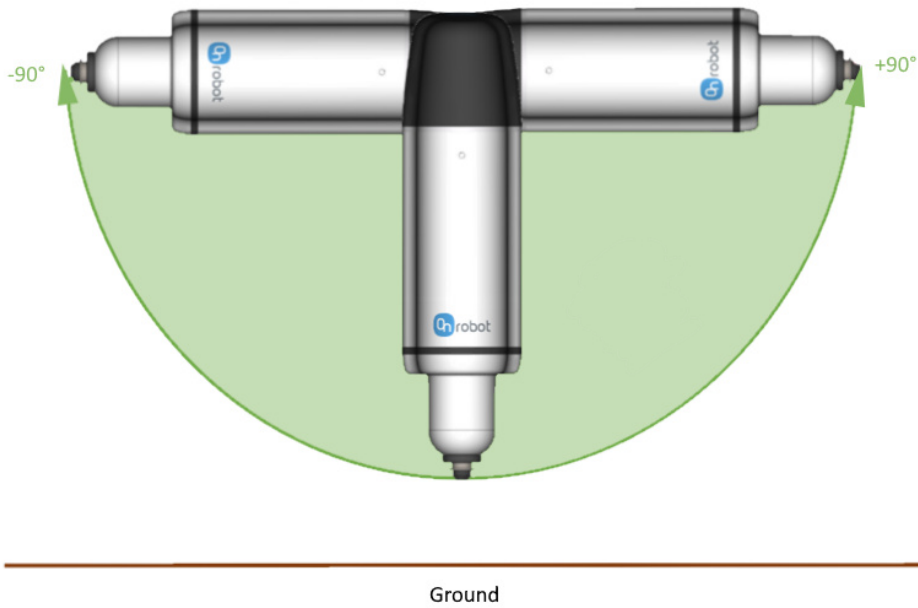

LED - Device Status

The screwdriver has a LED that shows the device status.

Color	Device Status
 No light	Power missing
 Steady green	Ready to work - Idle - Static
 Blinking green	Initializing
 Steady orange	Busy – Moving/rotating shank
 Blinking orange	Operational malfunction
 Steady red	Not working – Hardware problem
 Blinking red	Safety – Emergency stop

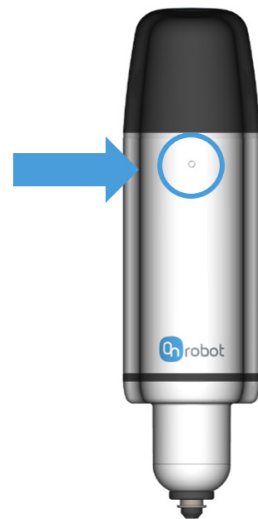

Torque Angle Curve and Torque Gradient

The torque gradient shows how the torque is applied in the last phase of the Tightening screw command. This could be used as an indicator to detect if a Tightening command is performed correctly.



NOTE:

When using self-tapping screws, if the tapping torque is very close to the target torque, the torque gradient might provide an invalid value.

For instance, the torque gradient could be different if:

- The hole thread is not long enough
- The hole thread is different from the screw thread
- The hole thread is not clean (for instance by deburrs from CNC machining)
- The friction between the screw thread and the hole thread is too low or too high
- The friction between the screw head and the tighten part is too low or too high

A torque gradient variable is made available to be checked in the robot program.

The graph below shows a normal Torque/Angle curve. In this case has been made with an M4 screw and 2.4 Nm as target torque.

Torque angle curve Metric

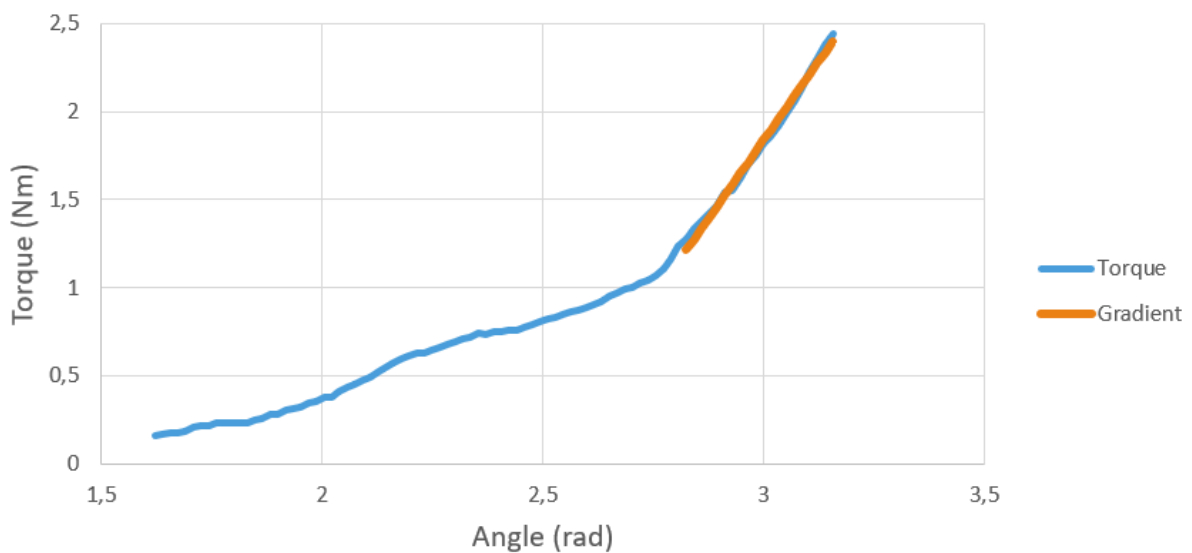

Torque angle curve US Standard

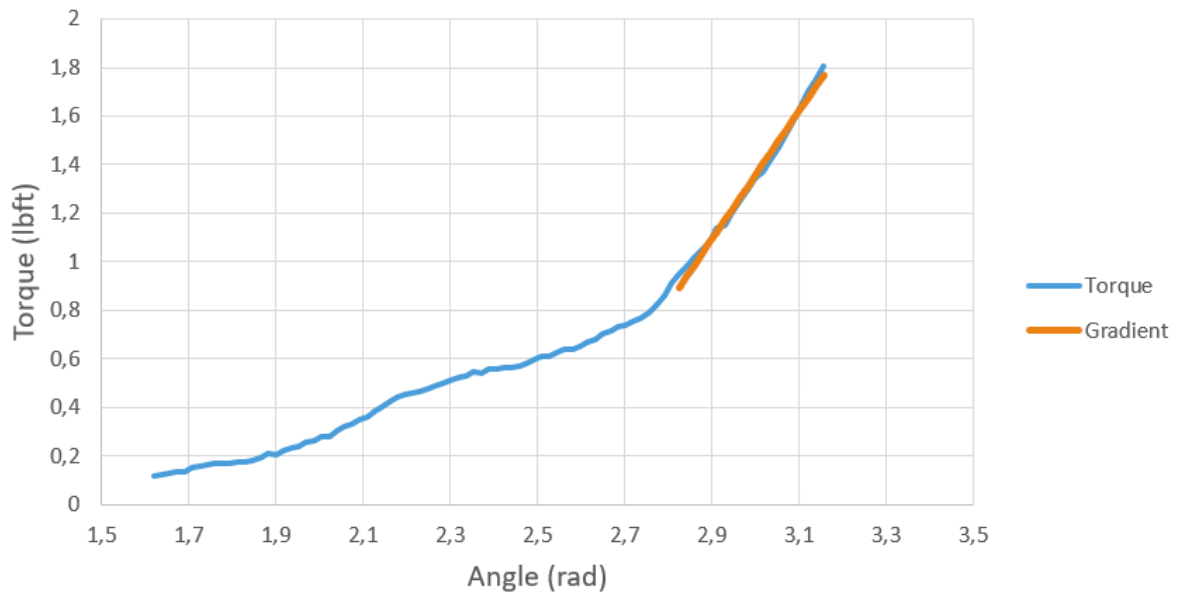

Adjusting the Bellow back in Place



NOTE:

Initially, the bellow should not come out of place, but if it does, follow the instructions below to adjust it back in place.

1. Remove the lid.

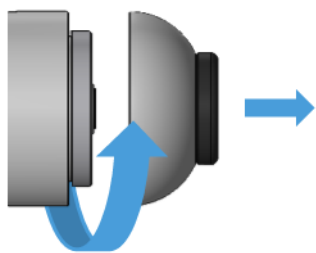

2. Move the shank to the highest possible value by using the user interface in the robot or in the Web Client.

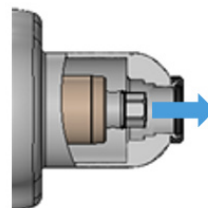

3. Adjust the bellow back in place.

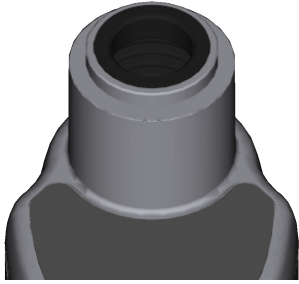

4. Place the lid back on.

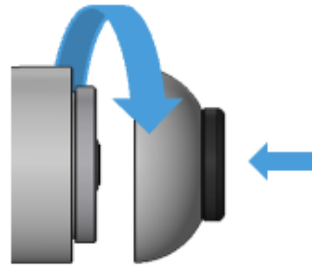

1.2. Screwdriver

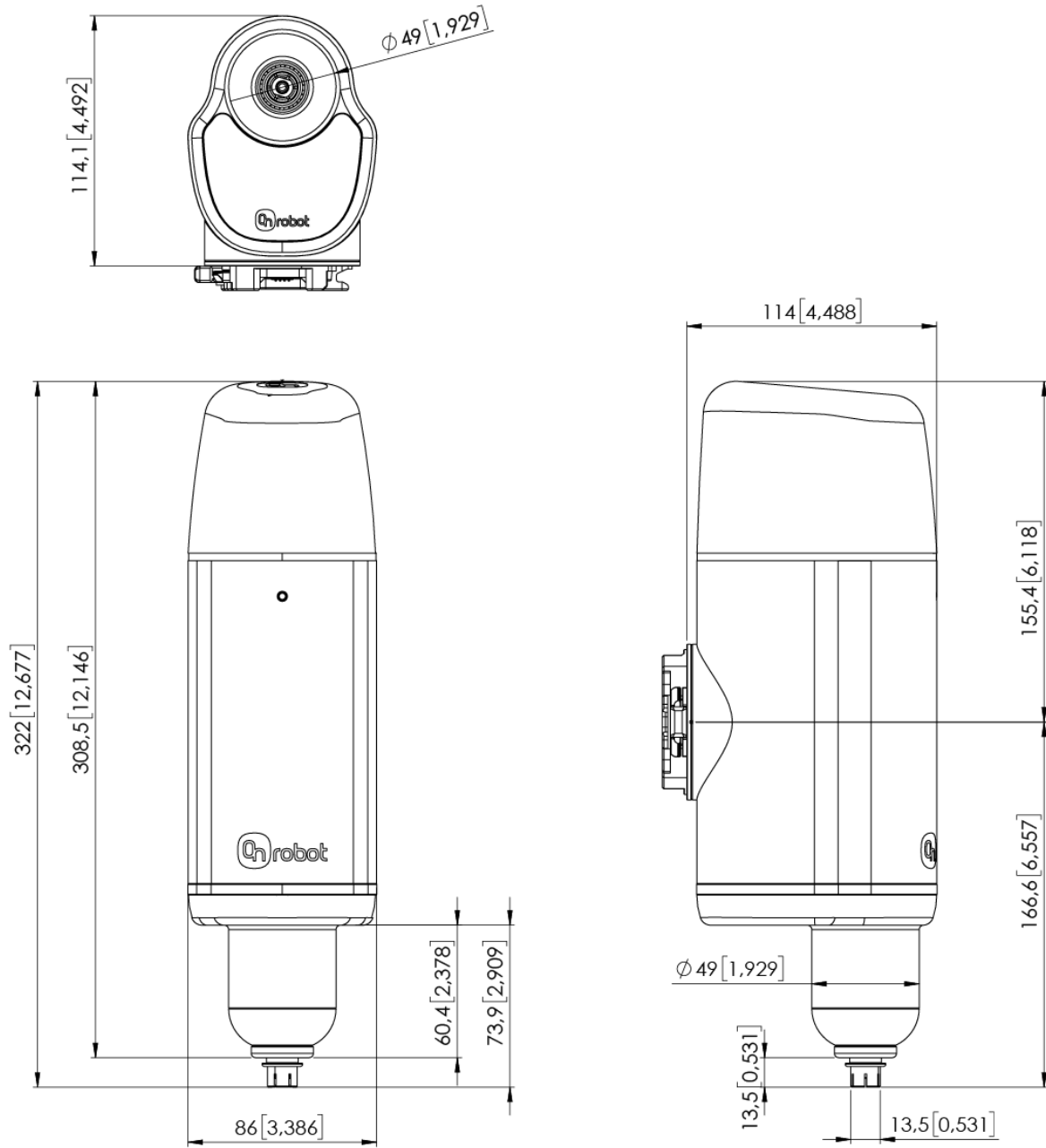

All dimensions are in mm and [inches].