



# PALLETIZING *SOLUTION*

*A permanent fix for all your staffing woes.*

**AX** *Series*

**PE** *Series*



Unmatched speed. Unmatched payload. Unmatched lead time.

---

## PUT AWAY YOUR HIRING SIGNS

Take advantage of a turnkey solution designed to provide you with reliability and autonomy.

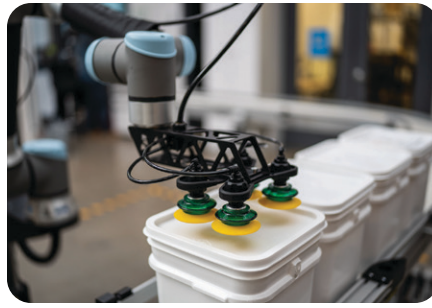

### ADAPTABLE

Effectively manage a wide range of box sizes, shapes, weights, and packaging materials. Hardware and software offer maximum flexibility and adapt to your production variety.



### USER FRIENDLY

Easy to operate, no matter your robotics knowledge level. The intuitive interface and intelligent software make it easy for anyone to teach the robot confidently and risk-free.

---

## EARN AN ROI WITHIN MONTHS

Scale production effectively with the fastest and strongest cobot palletizing solution.\*



### HIGHEST THROUGHPUT

Software consistently optimizes trajectories to maximize cycle time, for a solution that offers the greatest speed and highest payload capacity.\*

Up to 13 picks/minute, with a payload capacity of up to 11.5 kg (25 lb) and multipick capabilities.



### COMPACT

The human-sized solution fits easily within your existing floor space, and can work in hazardous, low-ceilinged environments.



Cobots allow us to have much smoother production lines, and that's exactly what we were looking for. We'll earn an ROI quickly—within 18 months—because labor is so expensive.

— Antoine Bruno, president at Alliora



---

## KEEP YOUR WORKFORCE SAFE

Free employees from manual and unsafe tasks, and improve their experience at work. The cobot-based Palletizing Solution does the heavy lifting while remaining safe to be around.

\*Compared to alternatives on the market, when using the same cobot.

# TURNKEY SOLUTION

Inspired by our lean robotics approach, we offer automation using a standard, pre-engineered solution. Compared to larger and higher-risk industrial automation projects, it deploys faster preventing scope creep and unnecessary production downtime.



[CLICK TO PLAY VIDEO ON YOUTUBE](#)

# SHORTEST LEAD TIMES

Standard products are built in-house and shipped with two-week lead time. Receive all parts on time, get your automation project running quickly, and benefit from automation faster.

## WHAT'S THE DIFFERENCE?

### AX Series UR10e

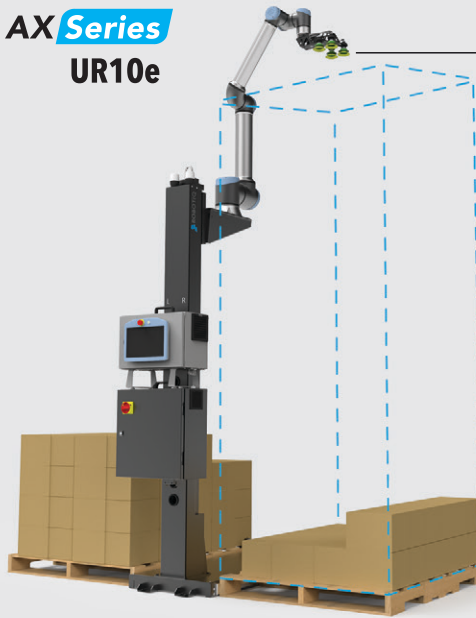

**Max pallet height**  
**2,750 mm**  
**(108 in)**

Fully integrated vertical axis for greater heights and optimal performance.

**Ideal for** handling a wide variety of box sizes and pallet heights.

### PE Series UR10e



**Max pallet height**  
**1,500 mm**  
**(60 in)**

Manually adjustable pedestal, from 950 to 1,500 mm (37 to 61 in) high in 50-mm (2-in) increments.

**Ideal for** less frequent changes in box size and pallet height.

### PE Series UR20

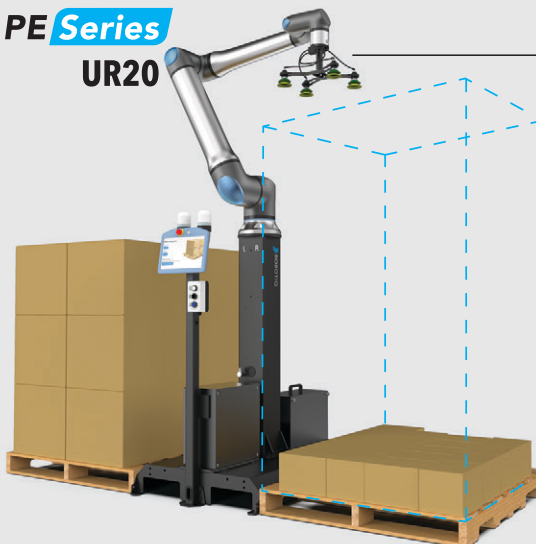

**Max pallet height**  
**2,150 mm**  
**(84 in)**

Reaching up to 2150 mm in a single setup.

**Ideal for** heavier loads and low to moderate pallet heights.

# CONFIGURATOR

Easily validate product fit for your application.

All you need to do is create the pallet pattern to automatically generate and optimize all trajectories and robot movements.

ROBOTIQ Units SI IMP. Robotiq Palletizing Solution

Share | Login

Robotiq Palletizing Solution

Looking for more information on the Robotiq Palletizing Solution? Check out our related content and eLearning below!

Get to know

Videos Learning E-Books Doc

Robotiq Palletizing Solution - Product video

Intro to the new Robotiq Palletizing Solution

1:44

KPIs

Configuration  
Extension bracket : ON  
Version : Default  
Robot Type : UR10

Box  
254 x 304.8 x 127 mm  
3 kg

Pallet  
1016 x 1219.2 x 130 mm  
48 boxes, 4 layers  
144 kg

Process  
12 boxes / min  
4:00 min / pallet

GET A QUOTE

Once your simulation is done, request a quote directly within the Configurator.

[designer.suite.robotiq.com/palletizing](https://designer.suite.robotiq.com/palletizing)

We'll team up with your local distributor and get itn touch with you.

Need support?

We can help you build your simulation for free.

[robotiq.biz/palletizing](https://robotiq.biz/palletizing)

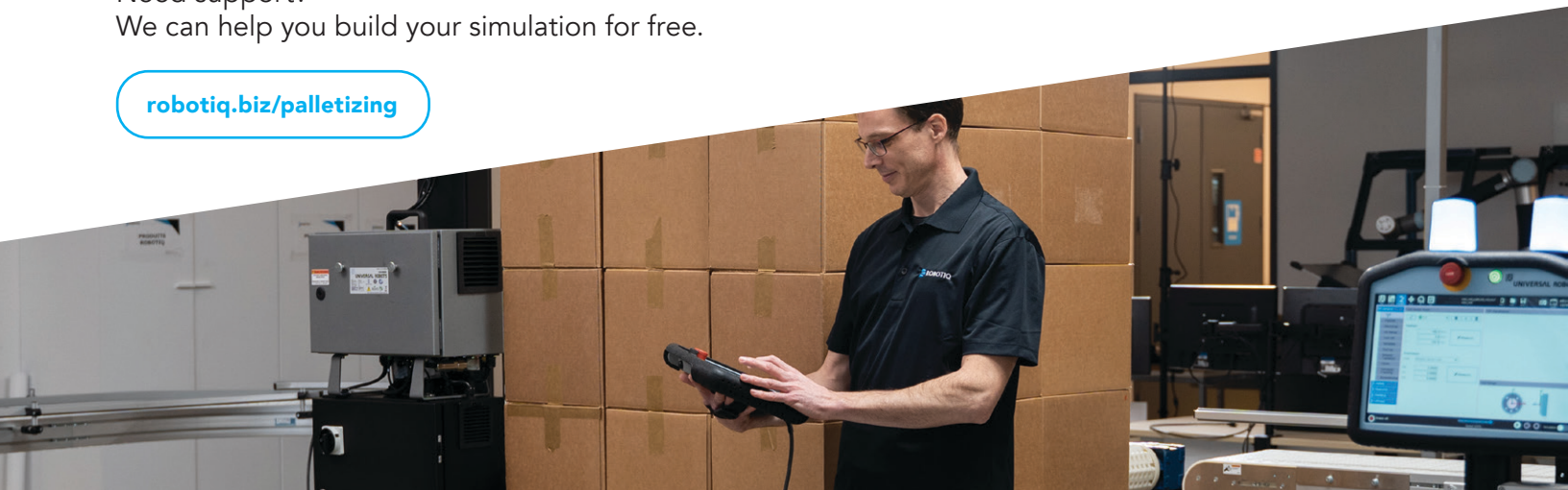

# SET UP YOUR APPLICATION IN 3 EASY STEPS

The Palletizing Solution is designed to make automation accessible, no matter your robotics knowledge level. All workers can operate and teach SKUs, risk-free.

Create a pallet pattern to automatically generate and optimize all trajectories and robot movements. The software stores hundreds of recipes (SKUs/pallets) for easier and faster changeovers.

Launching our first palletizing program took me less than 45 minutes.  
— Alliora employee

# 1

### ENTER BOX DIMENSIONS & WEIGHT

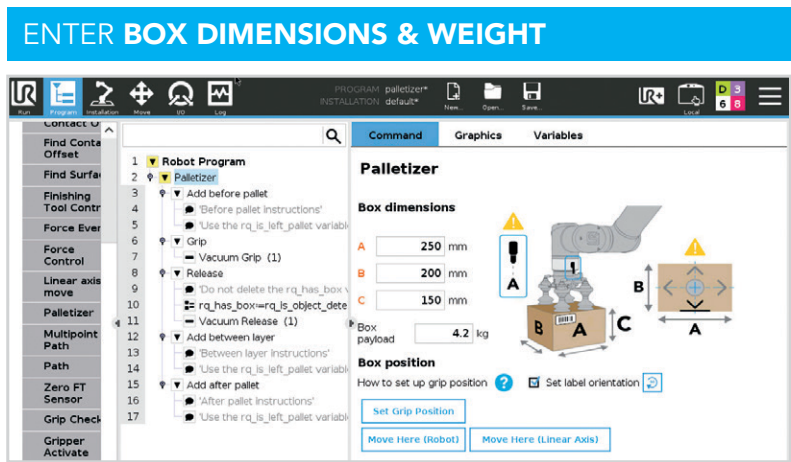

# 2

### ENTER PALLET DIMENSIONS

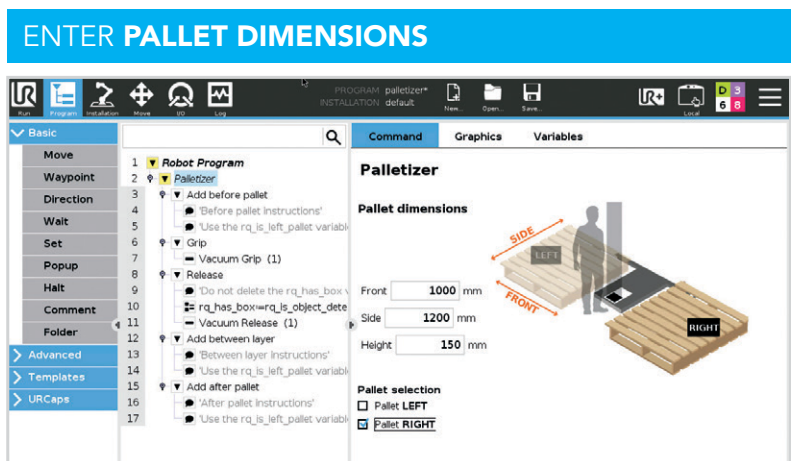

# 3

### SET PALLET PATTERN

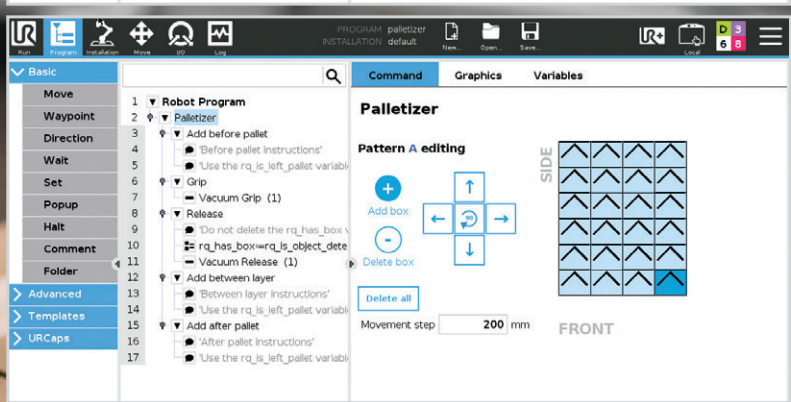
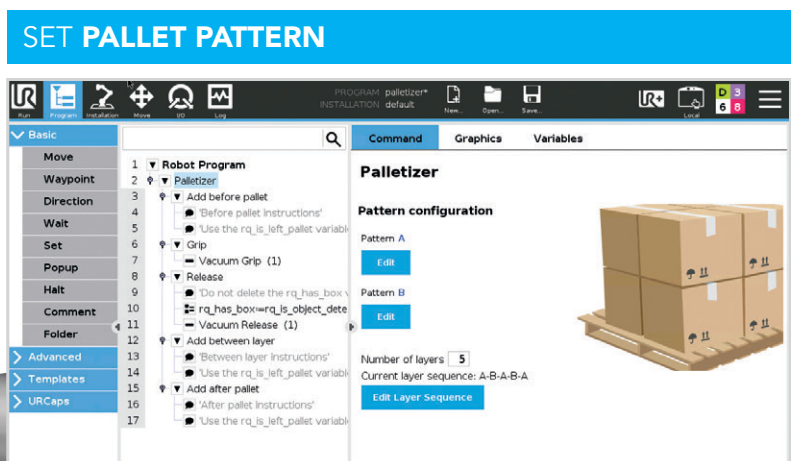

# SPECIFICATIONS

| CASE                                   | AX Series                       | PE Series | PE20 Series                   | PALLET                 | AX Series                                       | PE Series                           | PE20 Series                         |
|--|---------------------------------|-----------|-------------------------------|------------------------|---|-------------------------------------|-------------------------------------|
| Max payload without the gripper weight | Up to 12.5 kg<br><i>(28 lb)</i> |           | Up to 20 kg<br><i>(40 lb)</i> | Pallet width           | from 300 to 1,219 mm<br><i>from 12 to 48 in</i> |                                     |                                     |
| Max payload with the optional gripper  | Up to 11.5 kg<br><i>(25 lb)</i> |           | Up to 18 kg<br><i>(44 lb)</i> | Pallet depth           | from 300 to 1,219 mm<br><i>from 12 to 48 in</i> |                                     |                                     |
| Max throughput                         | Up to 13 cycles/min*            |           |                               | Pallet height (filled) | max<br>2,750 mm<br><i>max 108 in</i>            | max<br>1,550 mm<br><i>max 60 in</i> | max<br>2,150 mm<br><i>max 84 in</i> |

\*For one of multiple cases. Throughput depends on box weight, dimensions, and surface, as well as pallet dimensions and layout.

## CERTIFICATIONS AND STANDARDS

The Palletizing Solution is considered partly completed machinery and has been evaluated in accordance with the following harmonized standards:

- EN ISO 12100:2010
- 2011/65/EU + 2015/863 (RoHS Directive)
- 2012/19/EU (WEEE Directive)
- ISO 9409-1:2004

## WHAT'S INCLUDED?

- Ongoing customer support
- Palletizing hardware
- Palletizing software for UR with no recurring fees
- Optional Palletizing vacuum gripper, built specifically for palletizing

99%

customer satisfaction with our support service

in 2021 and 2022 surveys

> **46**  
**DIFFERENT CONFIGURATIONS**

Pick a wide range of box sizes, shapes, materials and weights without compromising stability.



## SERVICES

Our range of on-site and remote services is there to help you meet your cobot application needs as they evolve alongside your business.

### INSTALLATION SERVICES

A turnkey service in which our team or expert partners will **manage your project and take care of all the steps** needed to go from manual palletizing to automated palletizing. This service is tailored to your specific needs and may include pre-designed modules, such as:

- Palletizing installation and configuration.
- Customized training.
- Repeatable conveyor infeed setup.
- Slip-sheet management.
- Safety and risk assessments.
- CE marking.

### PROOF OF CONCEPT

Get peace of mind from our team of coaches. They'll help you check whether the Palletizing Solution will work for your application, prevent technical issues, and simplify your introduction to the robot world. Example services include:

- Demonstrate application fit.
- Validate cycle time.
- Demonstrate repeatability.

### ON-DEMAND TRAINING

Our personalized training will fast-track your factory's introduction to cobot palletizing. Remote or on-site, our training services are customized to your specific needs.

We also have an extensive library of eLearning modules, which cover Palletizing Solution setup, installation, daily use, and maintenance:

[elearning.robotiq.com](https://elearning.robotiq.com)



### TAKE ADVANTAGE OF OUR EXPERTS

They have sold and deployed hundreds of Robotiq Palletizing Solutions all over the world.

# 14-DAY DELIVERY LEAD TIME

Move fast on your automation project  
and accelerate your ROI.

**WHAT'S NEXT?**

To learn more or for any additional information, contact us:

[robotiq.biz/palletizing](https://robotiq.biz/palletizing) 1-888-Robotiq

