



UNIVERSAL ROBOTS

Installation Guide

**e-Series Injection Molding Machine
Interface (IMMI)**



The information contained herein is the property of Universal Robots A/S and shall not be reproduced in whole or in part without prior written approval of Universal Robots A/S. The information herein is subject to change without notice and should not be construed as a commitment by Universal Robots A/S. This document is periodically reviewed and revised.

Universal Robots A/S assumes no responsibility for any errors or omissions in this document.

Copyright © 2019-2020 by Universal Robots A/S.

The Universal Robots logo is a registered trademark of Universal Robots A/S.



Contents

1. Introduction	1
2. Safety	2
2.1. General	2
2.2. Safety Message Types	3
2.3. General Safety Precautions	4
2.4. IMMI Safety Precautions	6
2.5. IMMI Safety Functions	8
3. Product Description	9
3.1. Requirements	10
4. Robot Arm Cleaning and Inspection	12
5. Mold Area Free (MAF) Light Curtain	17
6. Hardware Installation	18
6.1. Installing the IMMI Module	19
6.2. Connecting the Ribbon Cable to the IMMI	20
6.3. Connecting the IMM	21
7. Software Installation	22
8. IMMI Module Programming	24
8.1. Program Structure	24
8.2. Creating a Program Structure	25
8.2.1. Program Structure Nodes	26
8.2.2. Using the IMMI Template	30
9. IMMI I/O in Regular Program Nodes	31
9.1. Using the IMMI I/O Overview	31
9.1.1. IMMI I/O Overview	31
9.1.2. How to Use IMMI I/O in Regular Program Nodes	33
10. Using the Robot without the IMM	34
10.1. Connecting the Bypass Plug	34
11. Specifications	35
11.1. Electrical Specifications	35
12. Copyright and Disclaimers	37
13. Compliance	38

1. Introduction

About this document

This guide describes how to install a Universal Robots Injection Molding Machine Interface (IMMI) module on a Universal Robots e-Series control box and how to configure the Injection Molding Machine Interface (IMMI) software, to interface with an Injection Molding Machine (IMM).

What's in the box

The box contains the following parts:

- IMMI module
 - Cables:
 - EUROMAP 67 / SPI AN-146
 - Ribbon cable
 - Ground (GND) wire:
 - M6 nut
 - M6 washer
 - Universal Robots EUROMAP 67 bypass plug
 - This document
-

Company Details

Universal Robots A/S
Energivej 51, 5260 Odense S, Denmark
+45 89 93 89 89
<https://www.universal-robots.com>

2. Safety

2.1. General

Description

Read the general safety information and the instructions and guidance pertaining to risk assessment and the intended use. Subsequent sections describe and define safety-related functions particularly relevant for collaborative applications.

**WARNING**

An application risk assessment must be performed for the safety of personnel and equipment.

Read and understand the specific engineering data relevant to mounting and installation, in order to understand the integration of UR robots before the robot is powered on for the first time.

It is essential to observe and follow all assembly instructions in the following sections of this manual.

**NOTICE**

Universal Robots disclaims any and all liability if the robot (arm Control Box with or without Teach Pendant) is damaged, changed or modified in any way. Universal Robots cannot be held responsible for any damages caused to the robot or any other equipment due to programming errors, unauthorized access to the UR robot and its contents, or malfunctioning of the robot.

2.2. Safety Message Types

Description

Safety messages are used to emphasize important information. Read all the messages to help ensure safety and to prevent injury to personnel and product damage. The safety message types are defined below.



WARNING

Indicates a hazardous situation that, if not avoided, can result in death or serious injury.



WARNING: ELECTRICITY

Indicates a hazardous electrical situation that, if not avoided, can result in death or serious injury.



WARNING: HOT SURFACE

Indicates a hazardous hot surface where injury can result from contact and non-contact proximity.



CAUTION

Indicates a hazardous situation that, if not avoided, can result in injury.



GROUND

Indicates grounding.



PROTECTIVE GROUND

Indicates protective grounding.



NOTICE

Indicates the risk of damage to equipment and/or information to be noted.



READ MANUAL

Indicates more detailed information that should be consulted in the manual.

2.3. General Safety Precautions

Description

This section contains general safety precautions, read it before installing the IMMI. For more information on safety, refer to the Safety section in the robot User Manual.



WARNING: ELECTRICITY

Performing installation or maintenance of equipment connected to a power source can lead to electric shock.

- Ensure the equipment is disconnected from the power source before performing installation or maintenance.



WARNING

Incorrect connection of the power source or ground wires can result in personnel injury or equipment damage.

Damage caused by invalid power source connection is not covered by warranty. Before starting the operation:

- Ensure the power source wiring is correct.
- Ensure the grounding is correct.



WARNING

Failure to verify and validate safeguarding and functionality can result in death or serious injury.

- Ensure all risk reduction works as intended and achieves the needed risk reduction.



WARNING

Failure to perform a risk assessment before installation and operation can result in personnel injury or equipment damage.

- Perform a risk assessment before installation and operation.
- Read the UR User Manual and UR Service Manual.



WARNING

This product includes the Universal Robots e-Series robot. General safety considerations that are valid for the Universal Robots e-Series robot are also valid for this product.

Failure to use the robot as described in the User Manual can lead to personnel injury.

- For more information on safety, refer to the Safety section in the Universal Robots e-Series robot User Manual.

2.4. IMMI Safety Precautions

Description This section contains safety precautions specific to installing the IMMI.



WARNING

Unauthorized modification of the IMMI module can result in personnel injury or equipment damage.

- Only qualified personnel must perform modifications.
- Perform a new risk assessment before and after modification.



WARNING

The absence of protection at the mold area to prevent access, or to detect presence in the mold area, can result in personnel injury or equipment damage.

- Based on the risk assessment, safeguarding can be required for risks associated with the mold area and also with the application of the UR robot.



WARNING

The Mould Area Free (MAF) signals are not intended for safeguarding.

- Integrate the UR robot, IMMI and any safeguarding in accordance with manufacturers specifications and applicable standards.
- Apply mold area safeguarding if there is a risk of operators reaching into the mold.



WARNING

Failure to coordinate the movement between the robot arm and the IMM can result in personnel injury or equipment damage.

- Read and understand the EUROMAP 67 recommendation.
- Read and understand the IMMI module user guide.
- Integrate the UR robot, IMMI and any safeguarding in accordance with manufacturers specifications and applicable standards.



NOTICE

Failure to connect the ground (GND) wire during installation can result in equipment damage.

- Connect the ground cable to the control box before connecting the ribbon cable.



NOTICE

Disconnecting the ribbon cable when the control box is powered on can result in equipment damage.

- Power off the control box before disconnecting the ribbon cable.

Emergency Stop

The robot and the IMM send Emergency Stop safety signals to each other through the IMMI. When a UR emergency stop is triggered, both the robot stops and the IMMI signals a stop to the IMM.



WARNING

Ensure all Emergency Stops halt the entire application before operating the application.

Safeguard Stop

When the UR robot Safeguard Stop is triggered by the IMM, the robot stops.



WARNING

Reaching into the IMM workspace can lead to serious personnel injury.

- Integrate safeguarding to protect personnel without reliance on the non-safety signals of the IMMI.

2.5. IMMI Safety Functions

Description This section contains information about the safety functions supported by the IMMI. Below describes the UR IMMI safety outputs. Consult with the IMM manufacturer for functional safety details of the IMM. These safety functions are in accordance with ISO 13849-1 and the connector pin assignments of EUROMAP 67 / SPI AN-146.

Safety function

UR Safety function	Cat./PL	PFHd
Emergency stop	3/d	2.33E-7
Safe guard stop	3/d	2.01E-7

Safety function 1

Emergency stop: Bidirectional	
Name	Emergency stop.
Type	UR robot: Stop category 1 according to per IEC 60204-1. IMM: See IMM documentation.
Triggering event	UR robot: Emergency stop push-button is pressed; stop triggered by IMM. IMM: See IMM documentation.
Reaction	UR robot: Stop category 1 according to per IEC 60204-1. IMM: See IMM documentation.
Safe state	UR robot: Drive power to the robot is removed; stop is initiated to the IMM through the IMMI. IMM: See IMM documentation.
Intended use	Stop all hazardous machine functions and remove power.

Safety function 2

UR safeguard stop input from the IMM	
Name	Safeguard stop.
Type	For safeguarding (protection) of personnel from IMM risks.
Triggering event	The IMM safeguard outputs change state, thereby triggering a safeguard stop to the UR robot.
Reaction and behavior on power failure	Robot stops upon loss of power to the UR robot. See IMM documentation to determine reaction of IMM and the safeguard upon loss of power to the IMM or the IMM safeguard.
Safe state	Robot is not moving and is in a monitored-standstill state (stop category 2 according to IEC 60204-1).
Intended use	IMM Safeguarding.

3. Product Description

Description The e-Series e-Series Injection Molding Machine Interface (IMMI) is an industrial solution for connecting a Universal Robots e-Series control box to an Injection Molding Machine.



WARNING

Failure to connect the e-Series Injection Molding Machine Interface (IMMI) properly can result in death or serious injury.

- Install the IMMI module properly to meet regulatory requirements.



NOTICE

Failure to install the e-Series Injection Molding Machine Interface (IMMI) properly can result in damage to equipment or property.

Use of product The certification for this product is only applicable to the stop interface of the e-Series Injection Molding Machine Interface (IMMI) on Universal Robots e-Series control boxes produced after 01 February 2020, where the control boxes are updated on the IMMI interface and are in compliance with EMC regulations.

Functional safety specifications are for the UR stop outputs on the IMMI. Integrated functional safety specifications are the responsibility of the integrator as this includes the specifications of the injection molding machine.

Components The e-Series Injection Molding Machine Interface (IMMI) consists of the following components:

- e-Series IMMI module
- e-Series IMMI cable

The e-Series Injection Molding Machine Interface (IMMI) application consists of the following components:

- Injection molding machine compliant with EUROMAP 67 / SPI AN-146.
- Universal Robots e-Series robot, consisting a collaborative robot arm and a UR e-Series control box (with Rev.F2 safety control board).
- e-Series IMMI module, including the IMMI module and an IMMI cable.
- Robot end-effectors e.g. grippers.

3.1. Requirements



NOTICE

Installing an e-Series Injection Molding Machine Interface (IMMI) in a control box with a serial number lower than 2020020161 can result in damage to equipment or property.

- Verify your control box serial number before installing the IMMI module.
- You can verify your safety control board if necessary.

Control box The control box serial number is located on the underside of the control box bracket. The following illustration shows the label and the control box serial number.

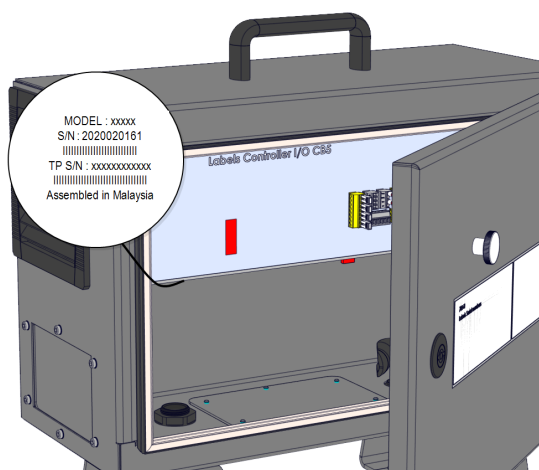

Safety control board

The safety control board serial number is located on the back of the safety control board. You must disassemble the control box bracket to access the Rev. F2 safety control board (F2 = RM).

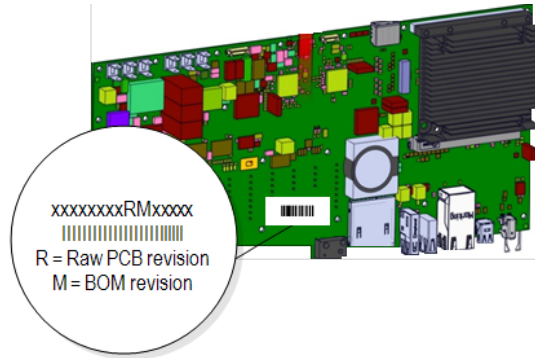
**NOTICE**

For more information about changing the safety control board, refer to the Control Box chapter in the Service Manual available on the support website:

- <https://www.universal-robots.com/support/>

4. Robot Arm Cleaning and Inspection

Description As part of regular maintenance the robot arm can be cleaned, in accordance with the recommendations in this manual and local requirements.

Cleaning Methods To address the dust, dirt, or oil on the robot arm and/or Teach Pendant, simply use a cloth alongside one of the cleaning agents provided below.

Surface Preparation: Before applying the below solutions, surfaces may need to be prepared by removing any loose dirt or debris.

Cleaning agents:

- Water
- 70% Isopropyl alcohol
- 10% Ethanol alcohol
- 10% Naphtha (Use to remove grease.)

Application: The solution is typically applied to the surface that needs cleaning using a spray bottle, brush, sponge, or cloth. It can be applied directly or diluted further depending on the level of contamination and the type of surface being cleaned.

Agitation: For stubborn stains or heavily soiled areas, the solution may be agitated using a brush, scrubber, or other mechanical means to help loosen the contaminants.

Dwell Time: If necessary, the solution is allowed to dwell on the surface for a up to 5 minutes to penetrate and dissolve the contaminants effectively.

Rinsing: After the dwell time, the surface is typically rinsed thoroughly with water to remove the dissolved contaminants and any remaining cleaning agent residue. It's essential to ensure thorough rinsing to prevent any residue from causing damage or posing a safety hazard.

Drying: Finally, the cleaned surface may be left to air dry or dried using towels.



WARNING

DO NOT USE BLEACH in any diluted cleaning solution.

WARNING

Grease is an irritant and can cause an allergic reaction. Contact, inhalation or ingestion can cause illness or injury. To prevent illness or injury, adhere to the following:

- **PREPARATION:**
 - Ensure that the area is well ventilated.
 - Have no food or beverages around the robot and cleaning agents.
 - Ensure that an eye wash station is nearby.
 - Gather the required PPE (gloves, eye protection)
- **WEAR :**
 - Protective gloves: Oil resistant gloves (Nitrile) impermeable and resistant to product.
 - Eye protection is recommended to prevent accidental contact of grease with eyes.
- **DO NOT INGEST.**
- In the event of
 - contact with skin, wash with water and a mild cleaning agent
 - a skin reaction, get medical attention
 - contact with the eyes, use an eyewash station, get medical attention.
 - inhalation of vapors or ingestion of grease, get medical attention
- After grease work
 - clean contaminated work surfaces.
 - dispose responsibly of any used rags or paper used for cleaning.
- Contact with children and animals is prohibited.

**Robot Arm
Inspection
Plan**

The table below is a checklist of the type of inspections recommended by Universal Robots. Perform inspections regularly as advised in the table. Any referenced parts found to be in an unacceptable state must be rectified or replaced.

Inspection action type			Timeframe		
			Monthly	Biannually	Annually
1	Check flat rings	V		X	
2	Check robot cable	V		X	
3	Check robot cable connection	V		X	
4	Check Robot Arm mounting bolts *	F	X		
5	Check Tool mounting bolts *	F	X		
6	Round Sling	F			X

**Robot Arm
Inspection
Plan****NOTICE**

Using compressed air to clean the robot arm can damage the robot arm components.

- Never use compressed air to clean the robot arm.

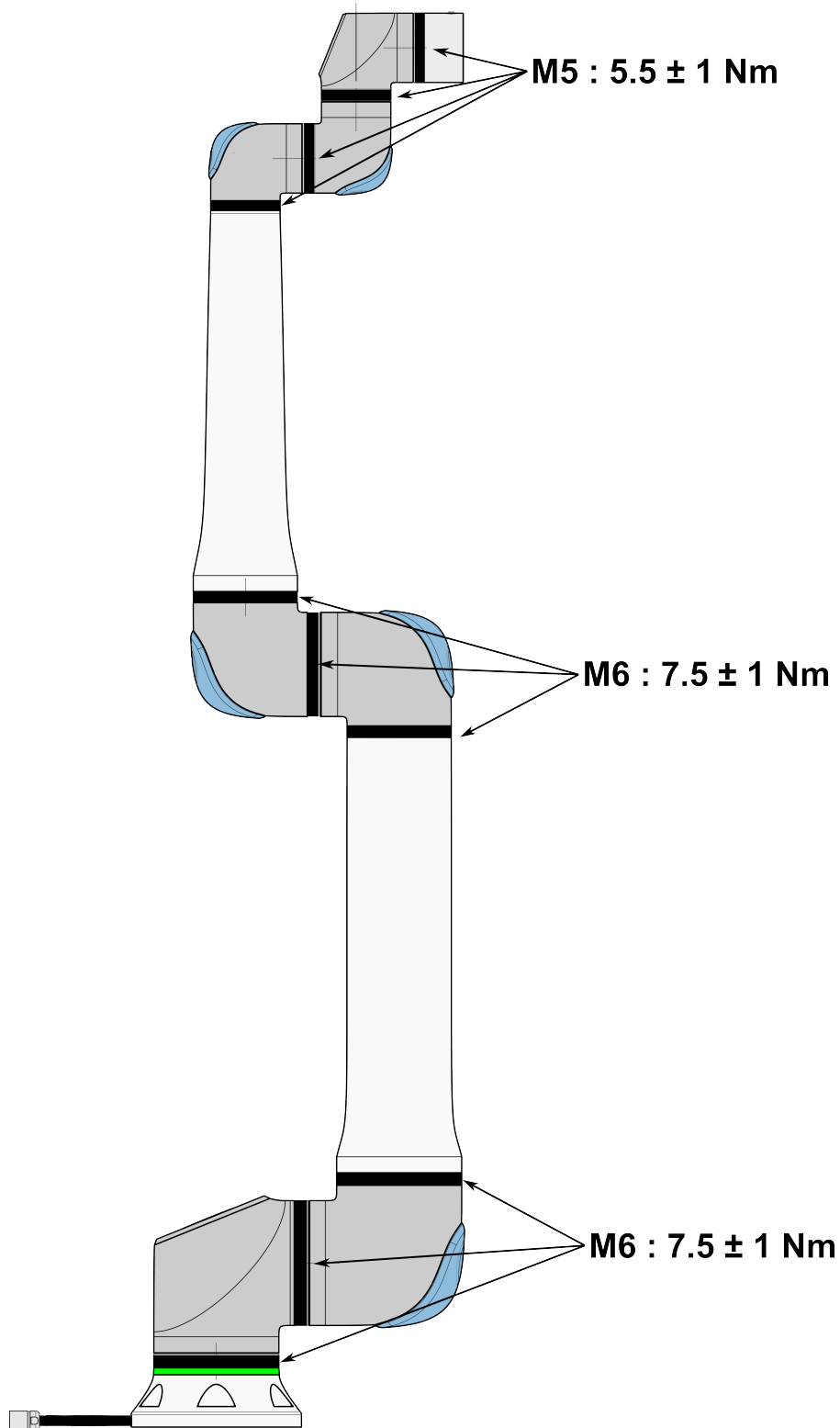

**Robot Arm
Inspection
Plan**

1. Move the Robot Arm to ZERO position, if possible.
2. Turn off and disconnect the power cable from Control Box.
3. Inspect the cable between Control Box and Robot Arm for any damage.
4. Check the base mounting bolts are properly tightened.
5. Check the tool flange bolts are properly tightened.
6. Inspect the flat rings for wear and damage.
 - Replace the flat rings if they are worn out or damaged.

NOTICE

If any damage is observed on a robot within the warranty period, contact the distributor where the robot was purchased.

Inspection

1. Unmount any tool/s or attachment/s or set the TCP/Payload/CoG according to tool specifications.
2. To move the robot arm in Freedrive:
 - On a 3PE Teach Pendant, rapidly light-press, release, light-press again and keep holding the 3PE button in this position.

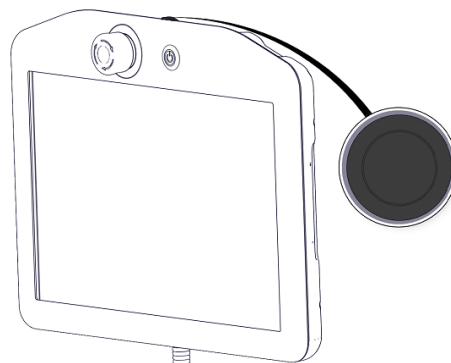

Power button

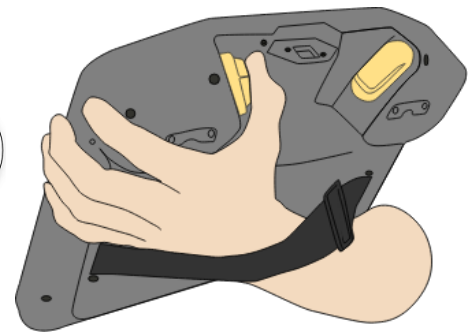

3PE button

3. Pull/Push the robot to a horizontally elongated position and release.

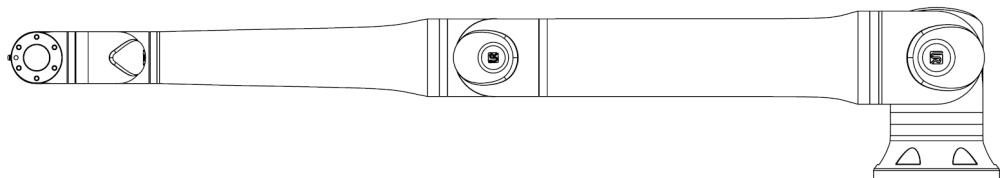

4. Verify the robot arm can maintain the position without support and without activating Freedrive.

5. Mold Area Free (MAF) Light Curtain

Description This section describes the EUROMAP use of a Mold Area Free (MAF) light curtain.



WARNING

The IMMI Mold Area Free (MAF) signals are not intended for safeguarding of personnel.

- Apply safeguarding if there is a risk of operators reaching into the mold.
- Integrate safeguarding in accordance with applicable standards, for example: IEC 62046, ISO 13855.



NOTICE

Failure to use a Mold Area Free (MAF) light curtain can result in unplanned mold closure which can cause equipment damage.

- Use the IMMI to signal the state of the MAF light curtain, if used.



NOTICE

The 24 V supply available from the MAF connector on the IMMI module is current limited. Exceeding the specified output current can result in a stop.

The MAF light curtain signal is not for safety purposes; it simply provides a status signal to the IMM.

Connect the MAF using the dedicated digital MAF input connector on the IMMI module. The MAF input is a pnp-type. When connected, the MAF input is high when the light curtain is not obstructed.

6. Hardware Installation

Description This section describes how to install the IMMI module hardware. For information on configuring the IMMI module software, see [7 Software Installation on page 22](#).

Required items You need the following items to install the IMMI module:

- One M6 nut
- One M6 washer
- A TX20 Torx screwdriver
- A box cutter with a 2.5cm (max) blade
- Cutting nippers

6.1. Installing the IMMI Module

To install the module

1. Power down the control box and disconnect the mains cable from the power source.
2. Remove the plate cover on the side of the control box.

Keep the screws and the tooth lock washers to continue installing the hardware.

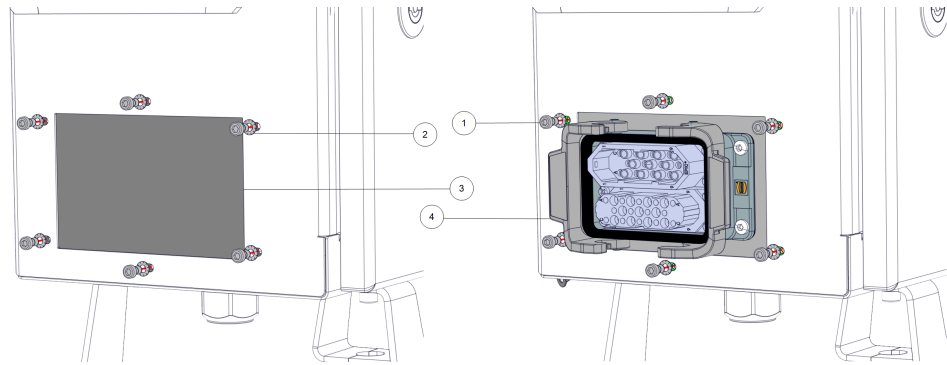

1	screw	2	tooth lock washer
3	removed plate	4	IMMI module

3. Orient the IMMI module so all ports are at the top, and use the screws and tooth lock washers from the control box plate to mount the module from the inside of the control box.



NOTICE

Torque the control box plate screws to 1.5Nm to avoid property damage.

4. Use the M6 nut and M6 washer to connect the ground wire to the IMMI module and the control box.

6.2. Connecting the Ribbon Cable to the IMMI



CAUTION

Removing the perforated strip can expose sharp edges, resulting in personnel injury.

- Handle the removed strip with care.



NOTICE

Inserting sharp and/or bladed tools too far into the EXTENSION BUS can result in property damage.

- Insert sharp and/or bladed tools into the EXTENSION BUS with care.

To connect the ribbon cable

1. Use the box cutter to cut through the EXTENSION BUS part of the control box label, and through the perforated strip.
2. Use the box cutter or cutting nippers to remove the perforated strip and expose the EXTENSION BUS connection port.
3. Connect one end of the ribbon cable to the newly exposed EXTENSION BUS connection port.
4. Connect the other end of the ribbon cable to the control box connection port.

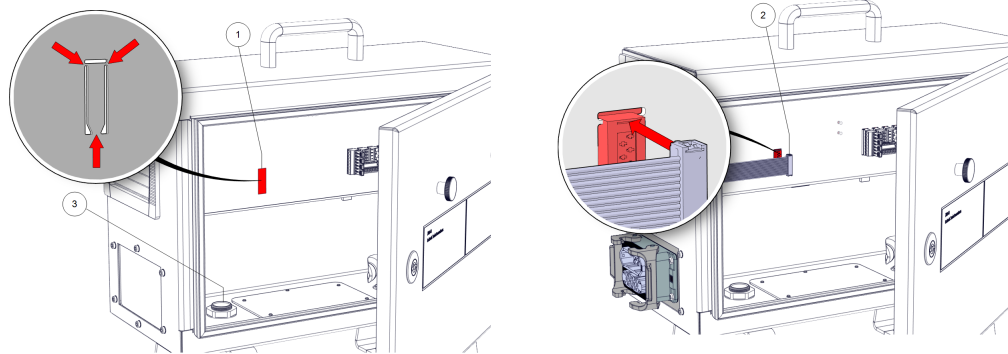

1	EXTENSION BUS connection port	2	ribbon cable
3	ground connection		



NOTICE

Incorrect ribbon cable connection can result in damage to property.

- Ensure the ribbon cable is in line with the top of the EXTENSION BUS connection port.

6.3. Connecting the IMM

To connect the IMM

1. Connect the IMM plug to the IMMI module and secure the safety clamps into place.
 2. Or connect the EUROMAP 67 bypass plug to the IMMI module and snap the clamps into place. See [10 Using the Robot without the IMM on page 34](#).
 3. Connect the mains cable to the power source and power on the control box.
 4. Wait for an on-screen message on PolyScope that the IMMI must be enabled in the Safety Settings.
-

7. Software Installation

Description

This section describes how to configure the IMMI module software.

For information on installing the IMMI module hardware, see [6 Hardware Installation on page 18](#).

To configure the IMMI Module Software

1. On PolyScope, in the Header, tap Installation and select **Safety**.
2. Tap Hardware and unlock the options on the **Select available hardware** screen.
A password is required to unlock this screen.
3. In the **Injection molding machine interface** drop-down list, select the desired recommendation.
4. Tap **Apply** to restart the system. PolyScope continues to run.
5. Tap **Confirm Safety Configuration** to complete the IMMI software installation.

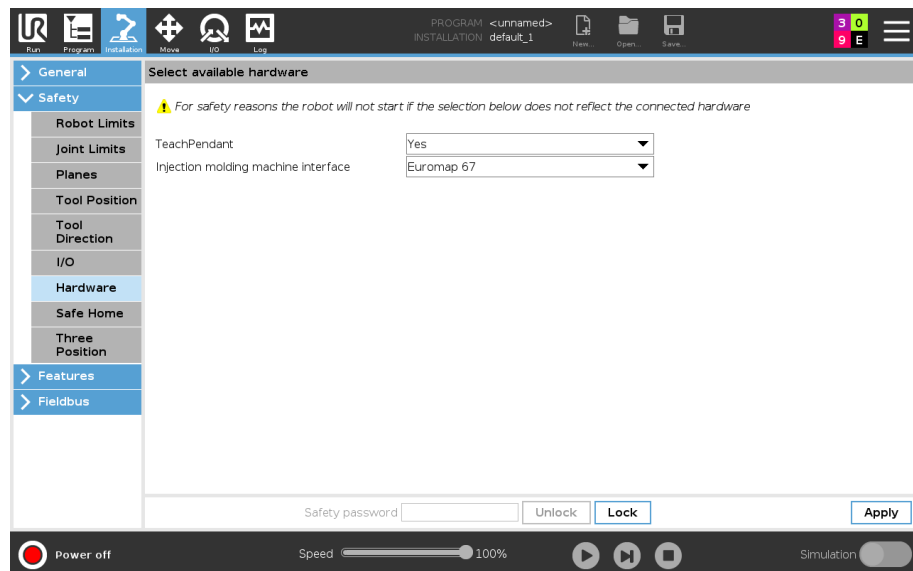

**To uninstall
the IMMI
Module**

1. On PolyScope, use your password to access the **Select available hardware** screen.
 2. In the **Injection molding machine interface** drop-down list, select **None**.
 3. Tap **Apply** to restart the system. PolyScope continues to run.
 4. Tap **Confirm Safety Configuration**.
 5. Power down the control box and disconnect the mains cable from the power source.
 6. Disconnect the IMM plug from the IMMI module.
 7. Dismount the interface.
 - Remove the ribbon cable.
 - Remove the M6 nut to disconnect ground connector.
 - Remove the M6 screws and tooth lock washers to remove the IMMI module.
 - Use the M6 screws and tooth lock washers to reattach the plate to the control box.
-

8. IMMI Module Programming

Description This section describes program structure functionality and how to create program structures, using the nodes available in the IMMI.

8.1. Program Structure

Description The program structures are nodes inserted into programs to achieve a proper and safe interaction with the IMM. They all include signal verification tests. You can also use the program nodes to ensure the I/O signals to and from the IMM are correctly configured. One program node can set up multiple outputs in a single action. To start creating a program structure for the IMM, select any of the program nodes available in the list under IMMI, as illustrated below.

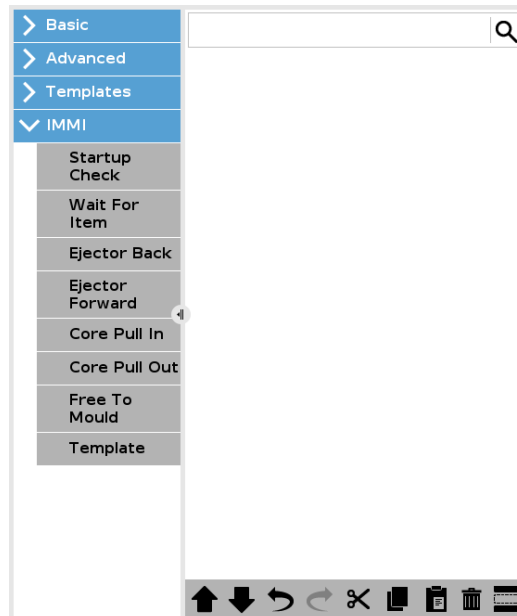

All program structure nodes consist of a set of steps. Most of the steps are enabled by default. Some steps cannot be disabled because they are essential to the program structure functionality.

Common step sets

Step set	Action
Test	The program stops if the test condition is not met.
Set output	The specified output is set to either high or low.
Wait until	Allows the program to wait until a movement is finished before continuing the program.

8.2. Creating a Program Structure

To create a program structure

1. On PolyScope, in the Header, tap Program and select **IMMI**.
2. Select the first desired program structure node from the options listed below.

You can select as many nodes as required by your program.

- **Startup Check:** Ensure the robot and the IMM are correctly set up before molding starts.
 - **Wait for Item:** Robot waits for an IMM item to be ready.
 - **Ejector Back:** Ejector returns to back position.
 - **Ejector Forward:** Ejector removes an item from the mold.
 - **Core Pullers In:** Select which core pullers move to position one.
 - **Core Pullers Out:** Select which core pullers move to position two.
 - **Free to Mold:** Signals the IMM to start molding
 - **Template:** Uses a predefined program structure
3. Under **Command**, check or uncheck the relevant checkboxes for each of your program nodes.

The checkboxes you select make up the set of actions the program node executes. This is illustrated below.

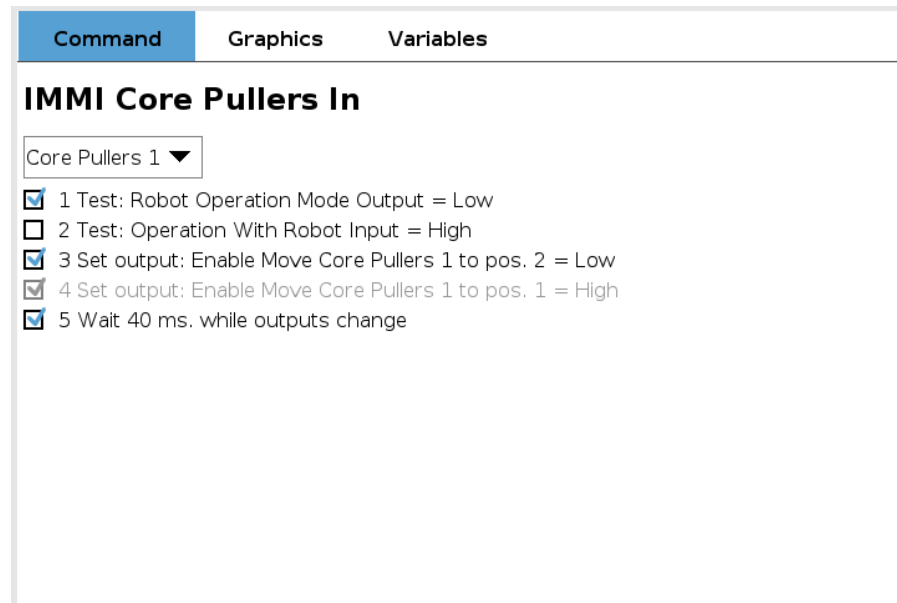

The following subsections illustrate and describe each program structure node.

8.2.1. Program Structure Nodes

Description

You can configure the step sets in each node by using the checkboxes to enable/disable individual steps.

Startup Check

Intended for use once at the beginning of a robot program, this node ensures the robot and machine are set up correctly before molding starts.

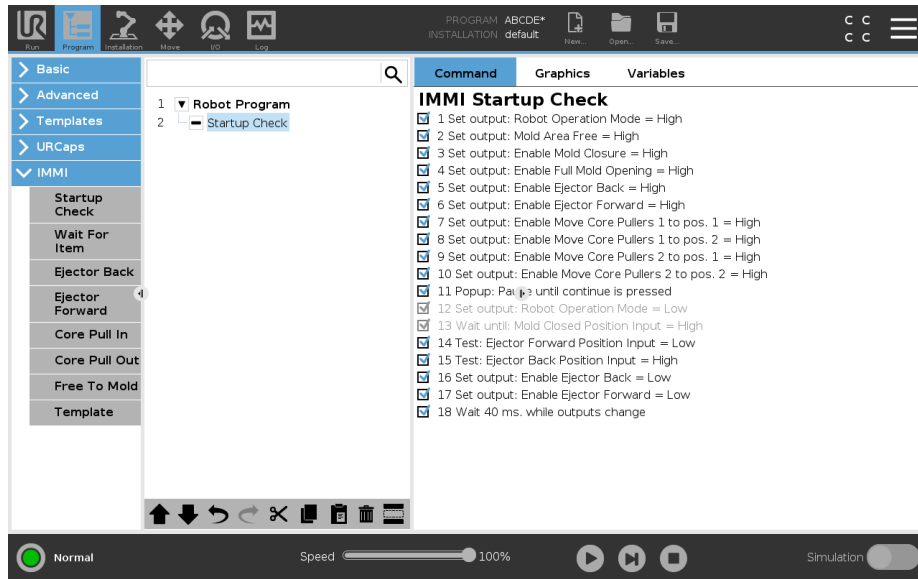

Wait for Item

Intended for making the robot wait until an item is ready from the IMM.

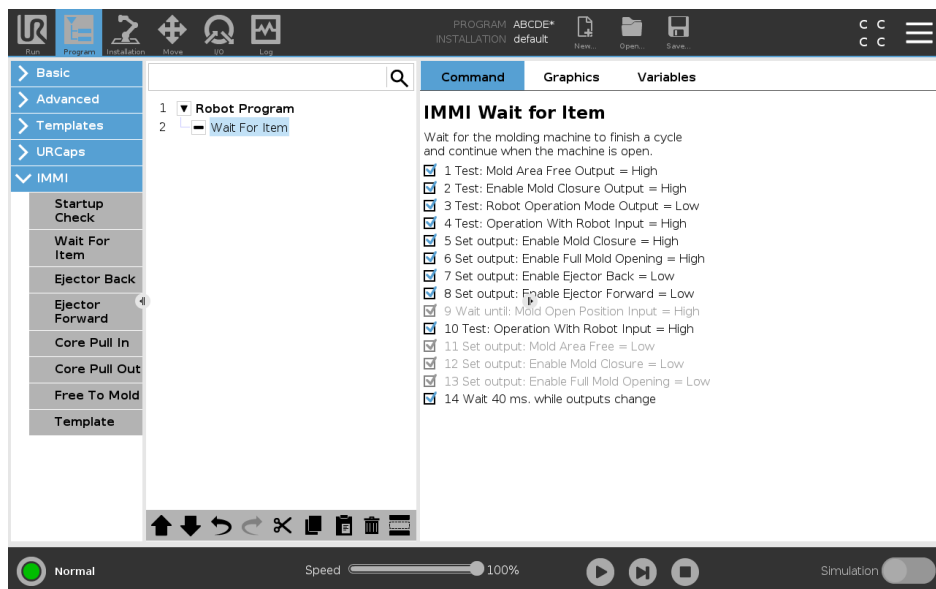

Copyright © 2019-2020 by Universal Robots A/S. All rights reserved.

Ejector Back

Enables the movement of the ejector to its back position.

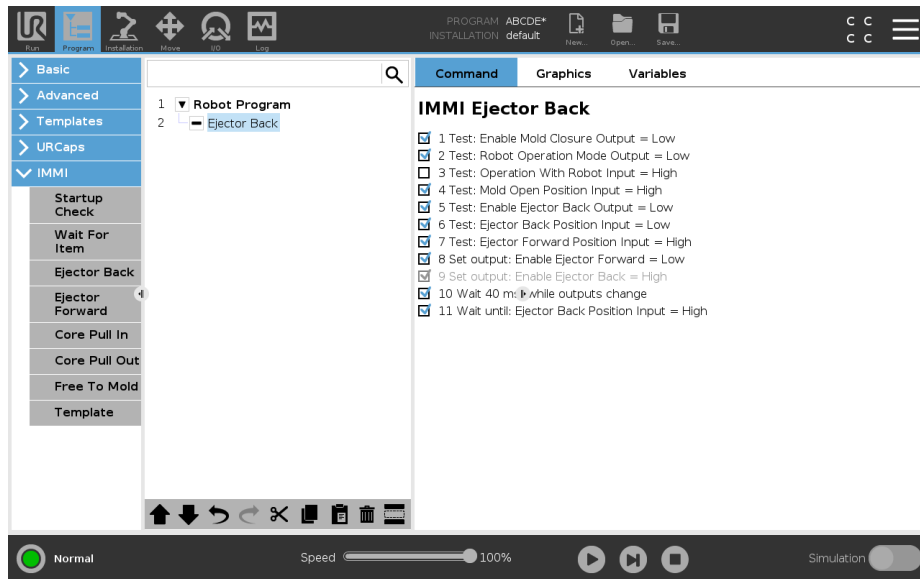

Ejector Forward

Enables the movement of the ejector to remove an item from the mold. Should be used when the robot is in position ready for grasping the item.

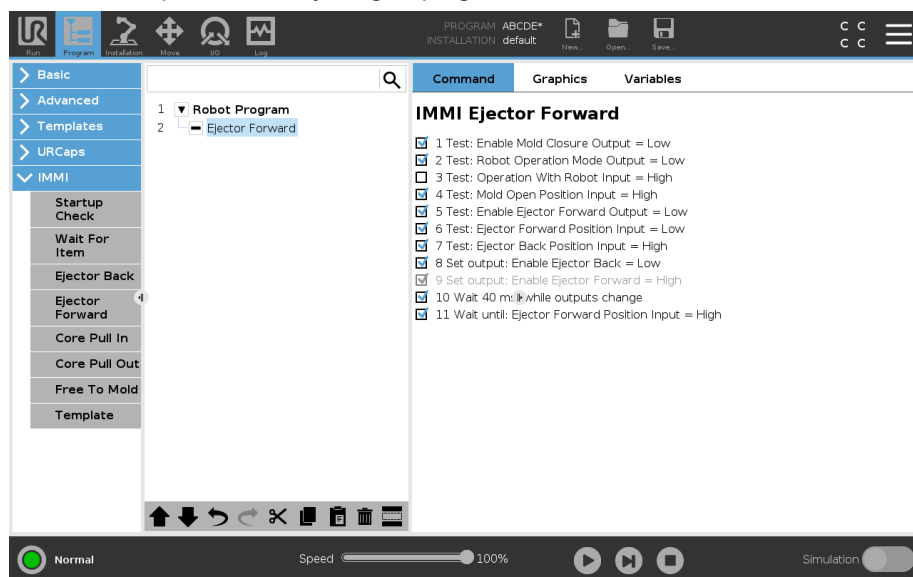

Core Pullers In Enables the movement of the core pullers to position 1. The core pullers used are selected from the drop down menu.

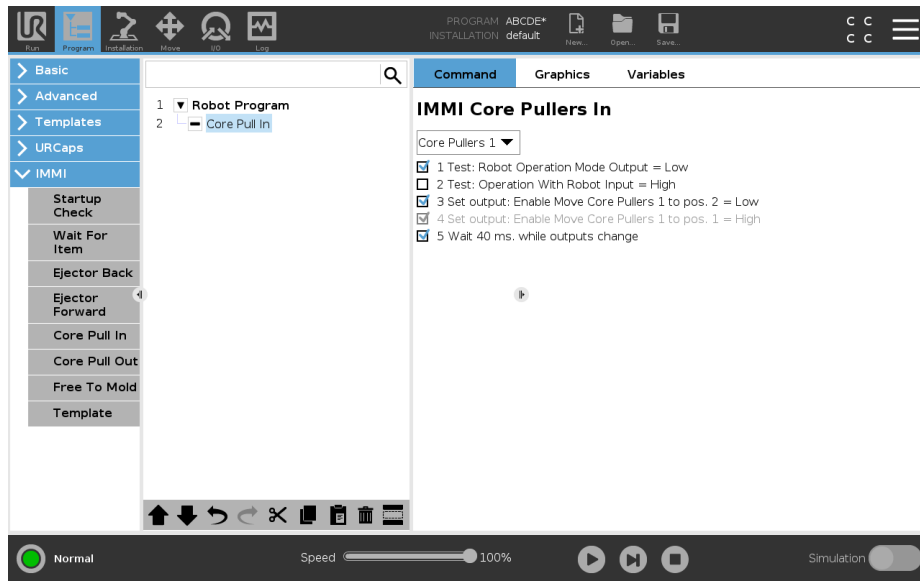

Core Pullers Out Enables the movement of the core pullers to position 2. The core pullers used are elected from the drop down menu.

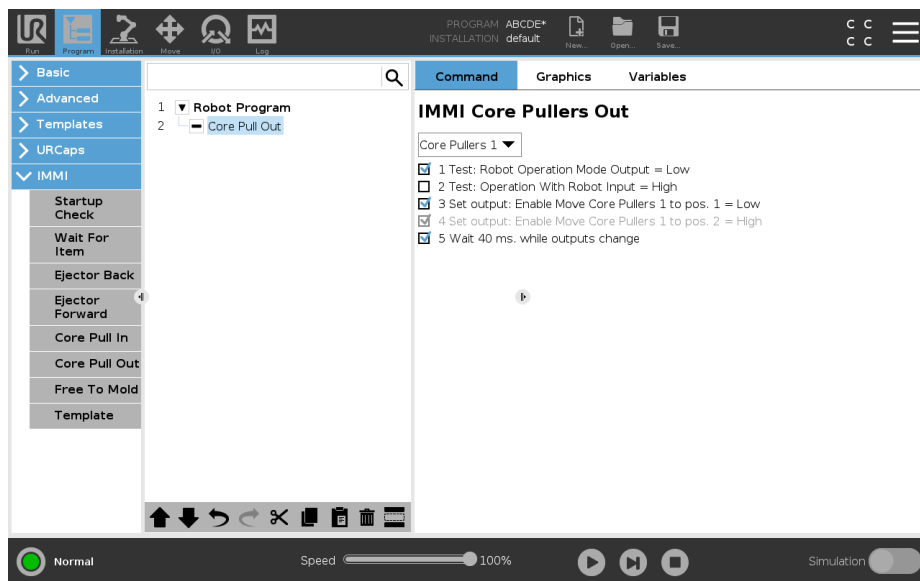

Free to Mold

Signals to the IMM that it is allowed to start a molding operation. When this signal is activated, the robot must be placed outside the IMM.

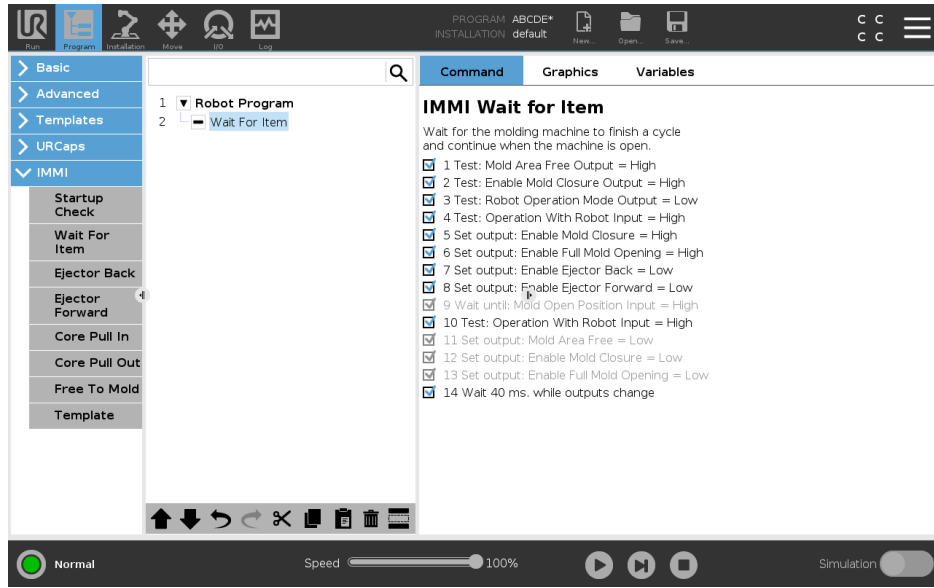

Template

Uses a predefined program structure to perform simple interaction with the IMM.

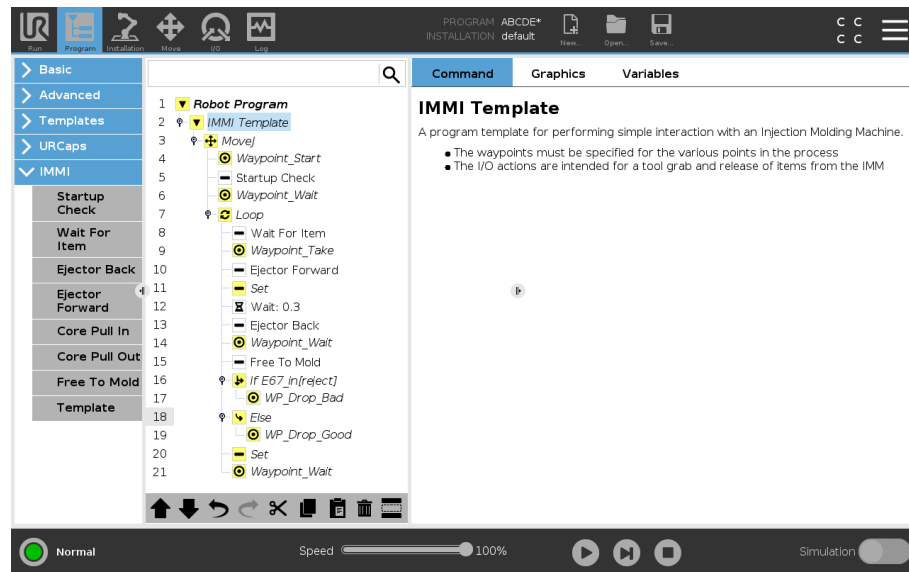

8.2.2. Using the IMMI Template

To use the IMMI template

1. On PolyScope, in the Header, tap Program and select **IMMI**.
2. Select **Template** for the program screen to appear with the template loaded. The template structure is visible on the left side of the screen, as illustrated below.

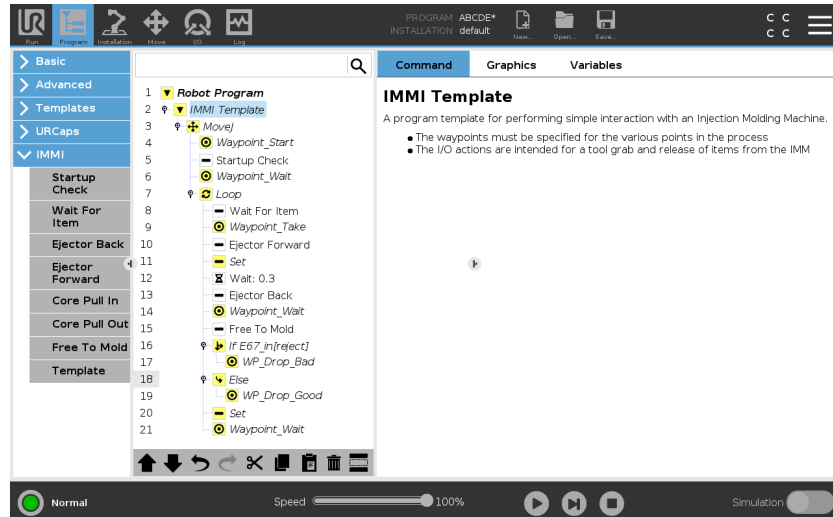

3. To prepare the robot for handling objects, select desired waypoints from the following:
 - **Waypoint_Start**: Robot arm start point before the injection molding process begins.
 - **Waypoint_Wait**: Robot arm wait point.
 - **Waypoint_Take**: Robot arm remove item from IMM point.
 - **WP_Drop_Bad**: Robot arm release rejected item point.
 - **WP_Drop_Good**: Robot arm release accepted item point.
4. Select and customize one of the following nodes to control the gripper:
 - **Set**: Determine when the tool grips and releases an item.
 - **Loop**: Run the robot only when an item must be removed from the IMM.
 - **MoveJ**: Adjust the robot movement speed to fit the IMM cycle time.
5. In the Move node, adjust the Joint Speed and Joint Acceleration to accommodate item fragility.

9. IMMI I/O in Regular Program Nodes

Description This section describes how to use IMMI inputs and outputs in regular program nodes.

9.1. Using the IMMI I/O Overview

Description The IMMI I/O screen provides indicators for inputs signals and options for controlling output signals. The options to control the output signals are, by default, only available in robot programming mode. This can be reconfigured as desired in the I/O setup tab found on the Installation screen.
On start-up, the 24V signals are high. All other signals are low.
In Automatic mode, all signals are high by default.

9.1.1. IMMI I/O Overview

Control These signals are used by the program structures to control the interaction between the robot and the IMM.

The Mold Area Free (MAF) cannot be controlled in the robot column screen. The MAF output is set high under the condition that the electrical supervision signal of the mould area and the MAF signal from the software are both high. The MAF signal from the software can be controlled by the respective button.

Status These signals are used to view and control the robot's operational mode and the IMM. The bars showing voltage and current consumption represent the values delivered by the IMMI module to the IMM and the light guard if used.

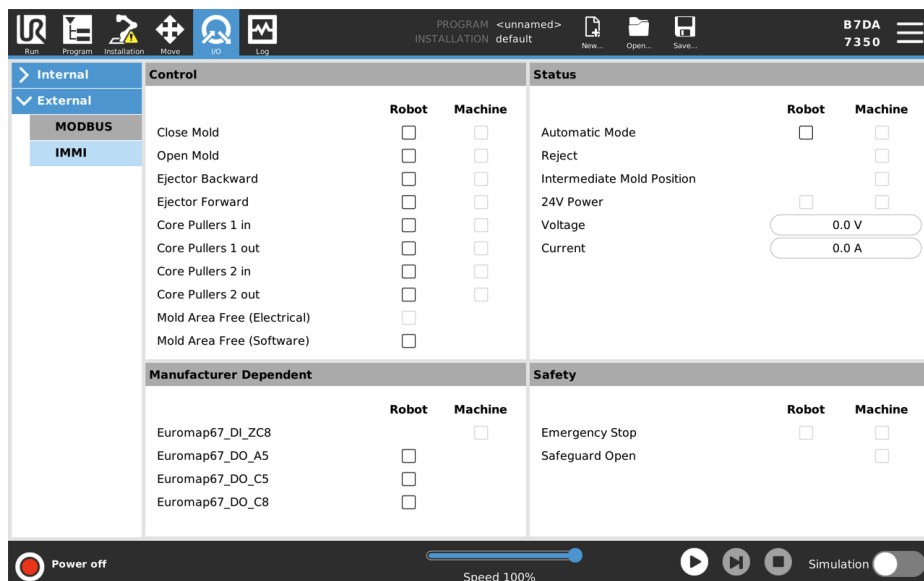

Copyright © 2019-2020 by Universal Robots A/S. All rights reserved.

Manufacturer Dependent These signals are optional, but can be used, as needed, for specific purposes by the IMM manufacturer.

Safety In the robot column, the Emergency Stop indicator cannot be controlled from this screen. It simply indicates the robot is emergency stopped.
The emergency stop signal from the machine indicates whether the IMM is emergency stopped.
The Safeguard Open input shows the state of the "Safety devices" signals specified in the EUROMAP 67 standard.

If a program structure does not include I/O signals, but still intended for use in a robot program, you can use the [Action and Wait nodes described in the following section](#).

9.1.2. How to Use IMMI I/O in Regular Program Nodes

- Wait**
1. On PolyScope, in the Header, tap **Program**.
 2. Under Basic, select **Wait**.
 3. In the Command panel, under Wait, select **Wait for Digital Input** to access the IMM input options.

- Set**
1. On PolyScope, in the Header, tap **Program**.
 2. Under Basic, select **Set**.
 3. In the Command panel, under Select any of the following options
 - **Set Digital Output:** Select from a list of outputs from robot to IMM.
 - **Set:** Select outputs and use expressions together.
 - **Set Single Pulse:** Select outputs and define pulse duration.

- Expression** You can access the Expression Editor from multiple nodes.
1. Tap the desired node and select the **f(x)** text field to open the Expression Editor.



NOTICE

For more information, refer to the robot User Manual available on the support website:

- <https://www.universal-robots.com/support/>
-

10. Using the Robot without the IMM

Description

This section describes how to use an IMMI configured robot without the IMM. Disconnecting the IMM from the IMMI module triggers any Emergency Stops, rendering the robot unusable. A bypass plug closes the emergency and safety signals.

Use the bypass plug to allow the robot to function normally without being connected to the IMM.

The Control Box IP rating is maintained, when the bypass plug is connected.

10.1. Connecting the Bypass Plug

To connect the bypass plug

1. Unclamp the safety clamps and unplug the IMM from the IMMI module.
 2. Do not try to clear the System Emergency Stop message that appears on PolyScope.
 3. Plug the bypass plug into the IMMI module and secure the safety clamps.
 4. On PolyScope, tap **Go to initialization screen** to start the robot.
-

11. Specifications

11.1. Electrical Specifications

MAF, not safety-related

Parameter	Min	Typ	Max	Unit
24V Voltage tolerance	-10%	-	10%	V
Current available from 24V supply	-	-	750	mA
Overload protection	-	2	-	A
MAF Input high level voltage*	11	-	-	V
MAF Input low level voltage*	-	-	5	V
MAF Input voltage range*	-0.4	-	36	V
MAF Input current at 24V input voltage	-	11	-	mA

*With reference to ground (GND) from the IMMI.

Stop I/O, safety-related signals

The emergency stop output signals are controlled by force guided safety relays conforming to EN 50205. The switch contacts are galvanically isolated from all other signals, and conform to IEC 60664-1 pollution degree 2, overvoltage category II.

Parameter	Min	Typ	Max	Unit
ZA1-ZA4 Voltage*	22	24	26	V
ZC1-ZC4 Input Current (each output) at 24V input voltage	-	11	-	mA
ZC1-ZC4 Input voltage range*	-0.4	-	36	V
ZC1-ZC4 Input high voltage*	11	-	-	V
ZC1-ZC4 Input low voltage*	-	-	5	V
A1-C1 A2-C2 A3-C3 Current AC/DC	0.01	-	6	A
A1-C1 A2-C2 A3-C3 Voltage DC	5	-	50	V
A1-C1 A2-C2 A3-C3 Voltage AC	5	-	250	V

*With reference to ground (GND) from the IMMI.

Digital Inputs, not safety-related

The digital inputs are pnp-type, and are galvanically connected to the control box. The inputs are compliant with all three types of digital inputs defined in IEC 61131-2.

Parameter	Min	Typ	Max	Unit
Input current at 24V input voltage	-	11	-	mA
Input voltage range*	-0.4	-	36	V
Input high level voltage*	11	-	-	V
Input low level voltage*	-	-	5	V

*With reference to ground (GND) from the IMMI.

Digital Outputs, not safety-related

The digital outputs are pnp-type, and are galvanically connected to the IMM. The galvanic isolation between the IMM and robot potential conforms to IEC 60664-1 pollution degree 2, overvoltage category II. The outputs are constructed in compliance with IEC 61131-2.

Parameter	Min	Typ	Max	Unit
Source current per output	0	-	200	mA
Voltage drop when ON	0	70	300	V

12. Copyright and Disclaimers

The information contained herein is the property of Universal Robots A/S and shall not be reproduced in whole or in part without prior written approval of Universal Robots A/S. The information herein is subject to change without notice and should not be construed as a commitment by Universal Robots A/S. This document is periodically reviewed and revised. Universal Robots A/S assumes no responsibility for any errors or omissions in this document.

Copyright © 2019-2020 by Universal Robots A/S.

The Universal Robots logo is a registered trademark of Universal Robots A/S.



NOTICE

Universal Robots continues to improve reliability and performance of its products, and therefore reserves the right to upgrade the product without prior warning. Universal Robots takes care that the content of this document is precise and correct, but takes no responsibility for any errors or missing information.

Universal Robots disclaims any liability, even if all guidelines in this document are followed.



NOTICE

The Universal Robotse-Series Injection Molding Machine Interface (IMMI) has been developed in accordance with Euromap 67, version 1.11 (May 2015 edition) and SPI AN146, The Society of the Plastics Industry, publication No. AN146 (March 2006).

Universal Robots hereby disclaim any and all liability with respect to the IMM and its signal to the IMMI, including stop signals and its handling of the Universal Robots stop signals, as Universal Robots has no knowledge whether the IMM is developed in compliance with the aforementioned industry guidelines.

13. Compliance

Description	<p>This section contains information about recommendations, certificates and declarations valid for Universal Robots e-Series robots with IMMI modules.</p> <hr/>
EUROMAP 67	<p>The information contained in the IMMI Installation Guide complies with EUROMAP 67 Version 1.11, a free of charge recommendation for Injection Molding Machines that can be downloaded from www.euromap.org.</p> <p>The Universal Robots Injection Molding Machine Interface (IMMI) module, when powered on, conforms to all requirements in the EUROMAP 67 recommendation. When the IMMI module is powered down, the EUROMAP 67 recommendation specifies that every safety related signals shall be operative. Therefore, the IMMI module triggers the emergency stop, the MAF signal and all I/O signals when the control box is powered down.</p> <p>All optional, manufacturer dependent and reserved I/O signals are supported, see 9 IMMI I/O in Regular Program Nodes on page 31. The optional I/O fall outside of the default IMMI settings and can only be defined by the manufacturer.</p> <p>The interface is constructed with the same components and principles, and under the same test requirements, as the control box. The EUROMAP 67 interface falls under the Declaration of Incorporation, found in the Hardware Installation Manual.</p> <hr/>
Shipping materials	<p>As stated by our suppliers, Universal Robots e-Series robots shipping materials comply with the ISPM-15 requirements for producing wood packaging material and are marked accordingly.</p> <hr/>
Certification of quality	<p>Universal Robots is certified compliant with the standard ISO 9001:2015 by Bureau Veritas.</p> <p>Universal Robots e-Series robots undergo continuous internal testing and end-of-line test procedures. UR testing processes undergo continuous review and improvement.</p> <hr/>

Software Name: PolyScope 5
Software Version: 5.22
Document Version: 10.12.22

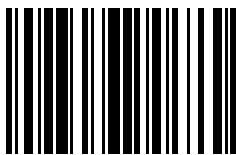

99373

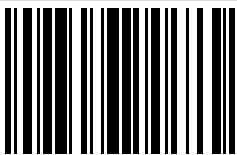

99373